

CMP BATH
PRODUCTS

2017

CUSTOMER RESOURCES

LOCATIONS

CORPORATE HEADQUARTERS

CMP EAST DISTRIBUTION

36 HERRING ROAD, NEWNAN, GA 30265

TOLL FREE: 1-800-733-9060

LOCAL: 770-632-7112

FAX: 770-632-7115

INFO@C-M-P.COM

CMP WEST DISTRIBUTION

5490 E. FRANCIS STREET, ONTARIO, CA 91761

CMP AUSTRALIA & NEW ZEALAND

(CSN GLOBAL PARTY LTD)

SALES@CSNGLOBAL.COM.AU

ONLINE: CSNGLOBAL.COM.AU

CMP EUROPE DISTRIBUTION

VELUWEZOOM 32, 1327 AH ALMERE, NL

INTERNATIONAL@C-M-P.COM

OEM SALES / PRODUCT INFO

MONDAY - FRIDAY: 8:00AM - 5:00PM (EST)

SPASALES@C-M-P.COM

ONLINE: C-M-P.COM/FIND-A-REPRESENTATIVE

CUSTOMER SERVICE / ORDERS

MONDAY - FRIDAY: 8:00AM - 6:00PM (EST)

1-800-733-9060

CS@C-M-P.COM

FAX: 770-632-7115

ONLINE: C-M-P.COM/CUSTOMER-SERVICE

For Ordering Terms & Details, See Page 91

TECHNICAL SUPPORT

MONDAY - FRIDAY: 8:00AM - 5:00PM (EST)

1-800-733-9060 EXT 220

SUPPORT@C-M-P.COM

WARRANTY/RMA

RMA@C-M-P.COM

MARKETING

To request product literature and other CMP Marketing resources, contact CMP Customer Service or your spa sales rep.

ONLINE

Visit WWW.C-M-P.COM for product info, resources, videos, news and support.

CATALOG: C-M-P.COM/CATALOG

ONLINE RESOURCES: C-M-P.COM/DOWNLOADS



TABLE OF CONTENTS

Welcome 4

CMP Bath Brands 5

Catalog Information 6

Color Reference 7

BATH JET COLLECTIONS 9

SÔL SERIES JETS 10

TECH SERIES JETS 17

ECON SERIES JET 22

BATH SERIES JETS 28

MINI JETS 32

CARESSE® SYSTEM 38

BATH EQUIPMENT 41

NEXXUS CONTROLS 42

NEXXUS PUMPS 54

NEXXUS DH HEATERS 58

NEXXUS AIR BLOWERS 59

CONTROL VALVES & BUTTONS 61

AIR CONTROLS 62

TOP MOUNT VALVES 66

SIDE MOUNT VALVES 67

WHITE GOODS 69

SUCTIONS 70

FITTINGS 74

UNIONS & CHECK VALVES 75

BATH MANIFOLDS 76

FLEX HOSE & TUBING 77

BATH ACCESSORIES 79

BATHTUB FEET 80

SHOWER ACCESSORIES 81

AROMA & CHROMATHERAPY 82

ADA GRAB BARS & SHOWER SEATS 84

SHOWER CURTAINS 85

Part Number Index 88

Terms & Conditions 91

CMP Limited Warranty 92



WELCOME

**CMP 2017 BATH
PRODUCTS CATALOG****SENIOR EDITOR**

Victor Walker

SENIOR EDITOR

JIM RAMSEY

DESIGN & CONTENT EDITOR

Stephen Boswell

ENGINEERING ADVISOR

Zack Vogtner

PRODUCT EDITOR

ALISON BRIGHT

PROJECT ASSISTANT

Susie Cuebas

The CMP Bath Products Catalog is a team project that included CMP Marketing, Engineering, Sales and Customer Service. Thank you to the entire team and to each individual that has contributed to the 2017 CMP Bath Products Catalog.

- EVERYTHING MATTERS®

©2017 CMP, LLC
All rights reserved

The bath is one of the most personal things in any home. That's why CMP works to provide suites of products to help OEMs create that personal bathing experience. Nexus™ controls create a custom simplified experience. Caresse® turns a bath into a soothing escape. SÖL™ designs disappear into the tub with a comfortable, flush finish. At CMP we are committed to continually working with you to provide the personal experience your customers want. Because when the difference in the details, everything matters.



WHAT'S NEW FOR 2017

CMP is proud to introduce the complete Nexus bath control system. The new, modern system features flexible control systems, solenoid operation, capacitive touch controls and simple LCD interfaces. (Page 41)



Nexus

CMP BATH PRODUCTS BRANDS

SÖL BATH COLLECTION

SÖL Bath is a European-inspired "flush" bath collection from CMP. The SÖL designs and forms are simple, elegant and graceful. The complete collection included bath jets, topside controls and suctions.

SOL COLLECTION: PAGE 10



The patent-pending design of Caresse® creates a soothing style of water therapy using the unique vented jet design. Caresse® gently wraps your body in ribbons of warm water.

Caresse® SYSTEM: PAGE 38

Nexxus™

CMP now offers a complete system of electronic components for bath. The Nexxus brand includes digital controllers, pumps, heaters and blowers. Equipment is available for U.S. and International markets.

NEXXUS EQUIPMENT: PAGE 41

The CMP logo, division "lockup" and tagline everything matters® are registered trademarks of Custom Molded Products,LLC. All CMP Bath Products logos and trademarks are property of CMP. SOL™, Caresse® and Nexxus™ are trademarks and/or registered trademarks of CMP.

The absence of a trademark, trade name or service mark from the above list does not constitute a waiver of our intellectual property rights concerning that trademark, trade name or service mark. All custom graphics, icons, logos and words listed above are trade names, trademarks or service marks of Custom Molded Products in the United States and/or other countries.

The trademarks and names of other companies and products mentioned herein are the property of their respective owners.

CATALOG INFORMATION

ABBREVIATION GUIDE

S = SOCKET

SB = SMOOTH BARB

WP = WHIRLPOOL

SP = SPIGOT

SS = STAINLESS STEEL

P/N = PART NUMBER

WTR = WATER

ASSY = ASSEMBLY

G. GRAY = GRAPHITE GRAY

RB = RIBBED BARB

GPM = GALLONS PER MINUTE

BOX AND BAG QUANTITIES

Box Quantities are listed for most items. If a bag quantity is also available, it will be indicated as "box/bag," such as "24/6" where "24" is the box quantity and "6" is the bag quantity.

Currently CMP does not apply a surcharge for broken carton orders. Please help us maintain this policy by ordering in full carton quantities. **Thank you for your cooperation.**

FOR MORE INFORMATION

Terms & Conditions pg 91

CMP Limited Warranty pg 162

All illustrations, photographs, product details and specifications in this catalog are current as of available information at the time of printing.

To access the digital version of this catalog, you may view or download online at www.c-m-p.com/catalog.



*Indicates CMP New
for 2017 Products*

THANK YOU FOR USING THE 2017 CMP BATH PRODUCTS CATALOG













COLOR REFERENCE

The standard CMP numbering scheme for designating the color of plastic products is indicated within the part number as follows:

A B C D E - F G H - I J K

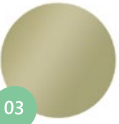
EXAMPLE: 23500-010-000 (10 = BRIGHT WHITE)

Always specify the product color by both name and number when placing orders to reduce errors.

					WHITE: SERIES 0 00 - White 10 - Bright White 20 - Medium White 30 - Oyster 40 - Classic White
					BONE: SERIES 5 15 - Bone 25 - Biscuit 35 - Almond
					BRASS: SERIES 3 03 - Polished Brass 23 - Oil Rubbed Bronze Aged*
					NICKEL: SERIES 8 08 - Brushed Nickel 28 - Polished Nickel CHROME: SERIES 2 02 - Polished Chrome

CUSTOM COLORS

Additional colors are available upon request. Custom colors can be provided. Please call for details. A minimum order will be required.

FITTINGS

Unless otherwise specified fitting bodies and other underskirt components are molded in white or gray.

SPECIAL ORDER *

Product colors marked with an asterisk are non-stock special order only.



BATH JET COLLECTIONS

SÖL™ SERIES JETS 10

TECH SERIES JETS 17

ECON SERIES JET 22

BATH SERIES JETS 28

MINI JETS 31

CARESSE® SYSTEM 36

SÖL

BATH COLLECTION

Introducing the *SÖL Bath Collection*, a European-inspired bath collection from CMP. The SÖL designs and forms are simple, elegant and graceful. A classic contemporary overtone allows SÖL to complement any bath design and decor. The complete SÖL Bath Collection includes suctions, lights, and controls for a total style package.



LUXURY PERFORMANCE

CONTEMPORARY STYLE

CLASSIC DESIGNS



SÖL BATH JETS

SERIES THREE

PRODUCT FEATURES

- Adjustable Flow Control
- Directional Nozzle
- Silicone Injection Ports
- 3.5" Round Face
- "L" or "V" Jet Body



2-3/4"/69.8mm Hole Size
3/8" Air × 26mm Water

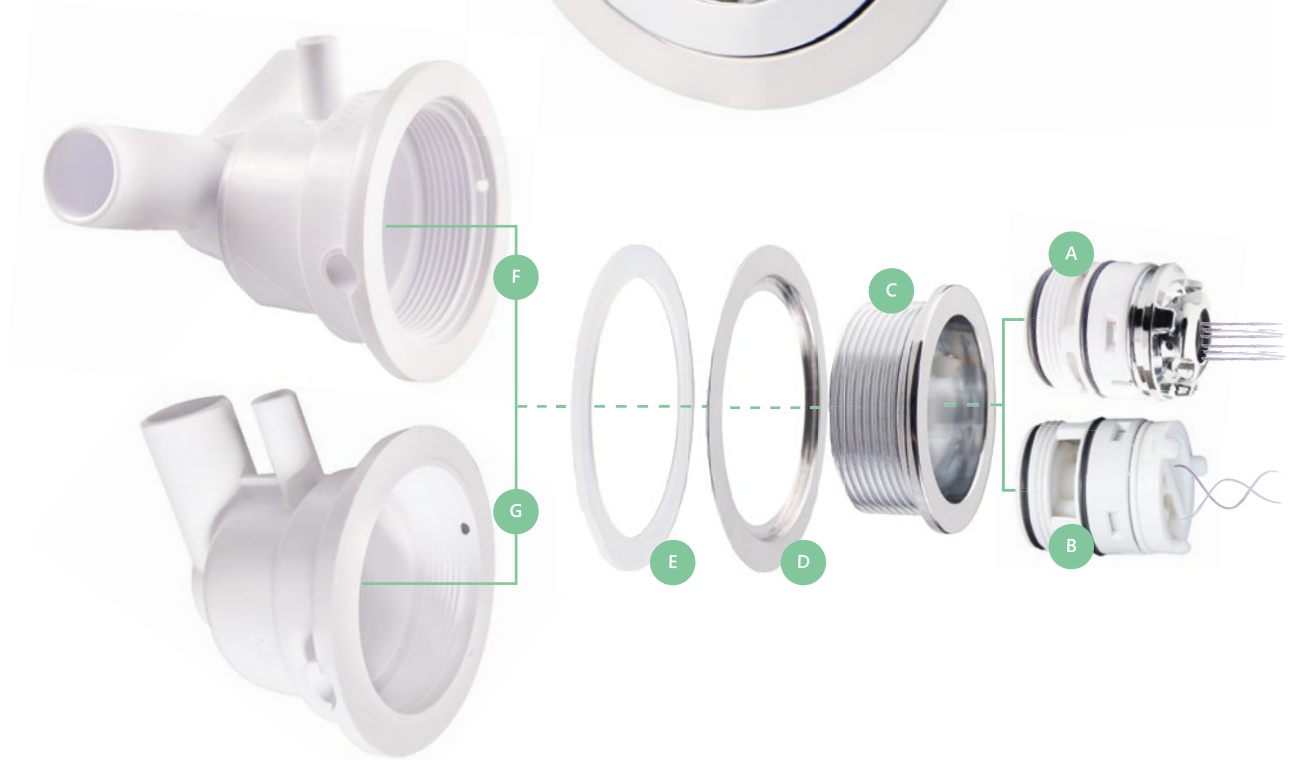

ORDERING GUIDE

REF	CMP P/N	DESCRIPTION	BOX QTY
SÖL SERIES THREE			
A	24601-002-000	SERIES THREE DIRECTIONAL & FLOW ADJUSTABLE INTERNAL	30
B	24600-000-200	SERIES THREE ROTATIONAL INTERNAL	30
C	24601-002-030	SERIES THREE WALL FITTING/TRIM RING	30
D	24601-002-040	SERIES THREE FLUSH ESCUTCHEON	30
E	24601-000-001	SERIES THREE GASKET	30
F	24600-000-010	SERIES THREE "V" JET BODY WITH CHECK VALVE	30
G	24600-000-020	SERIES THREE "L" JET BODY WITH CHECK VALVE	30
—	24601-999-999	JET TOOL FOR WALL FITTING	—

SÖL BATH JETS

SERIES TWO: DECO NON-ADJUSTABLE

PRODUCT FEATURES

- Stylish “Deco” Ring Design
- Silicone Injection Ports
- “V” or “L” or Body
- 2” Round Face
- Directional Nozzle

 1-11/16" / 42.4mm Hole Size
 3/8" SB Air
 26mm or 1" Water

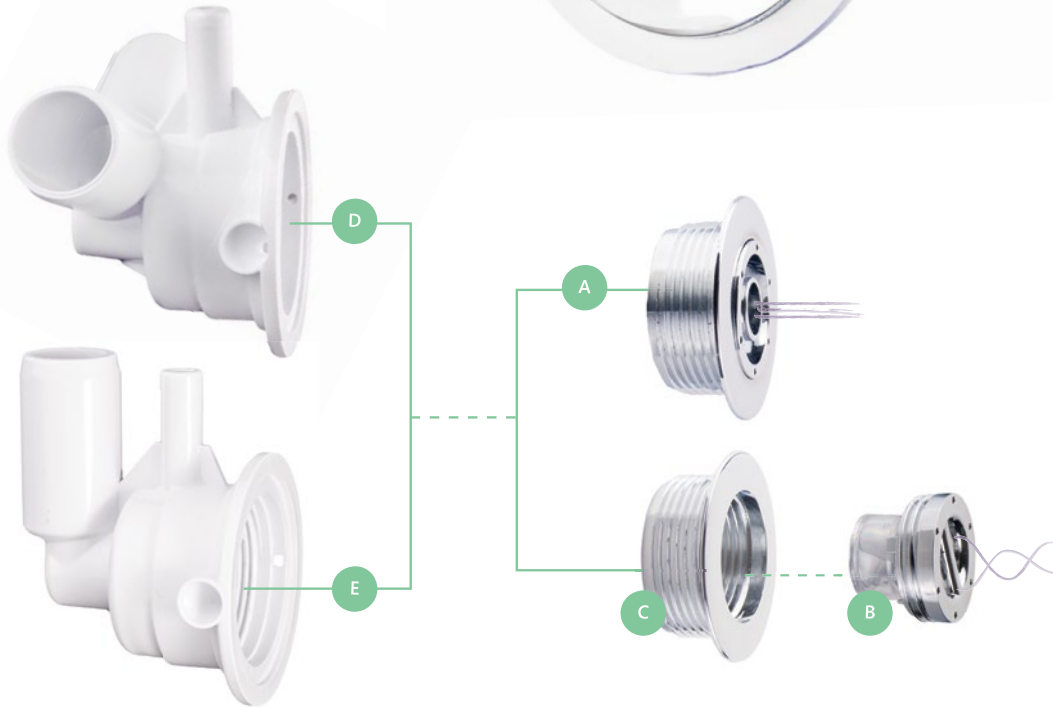

ORDERING GUIDE

REF	CMP P/N	DESCRIPTION	BOX QTY
SÖL SERIES TWO DECO NON-ADJUSTABLE			
A	24100-000-600	SERIES TWO DECO DIRECTIONAL NOZZLE & WALL FITTING ASSEMBLY, WHITE	50
A	24100-012-600	SERIES TWO DECO DIRECTIONAL NOZZLE & WALL FITTING ASSEMBLY, CHROME	50
B	24100-000-700	SERIES TWO DECO ROTO NOZZLE, WHITE	50
B	24100-002-700	SERIES TWO DECO ROTO NOZZLE, CHROME	50
C	24100-000-603	SERIES TWO DECO WALL FITTING, WHITE	100
C	24100-002-603	SERIES TWO DECO WALL FITTING, CHROME	100
D	24001-000-600	SERIES TWO DECO 26MM V-BODY (NON FLOW-ADJUSTABLE)	250
D	24101-000-600	SERIES TWO DECO 1" V-BODY (NON FLOW-ADJUSTABLE)	250
E	24101-000-620	SERIES TWO DECO 1" L-BODY (NON FLOW-ADJUSTABLE)	100
E	24001-000-620	SERIES TWO DECO 26MM L-BODY (NON FLOW-ADJUSTABLE)	100
—	24100-000-999	SERIES TWO WALL FITTING TOOL	—

SÖL BATH JETS

SERIES TWO: DECO ADJUSTABLE

PRODUCT FEATURES

- Stylish "Deco" Ring Design
- Silicone Injection Ports
- 2" Round Face
- "V" or "L" or Body
- Adjustable Flow
- Directional Nozzle

 1-11/16" / 42.4mm Hole Size
3/8" SB Air
26mm or 1" Water

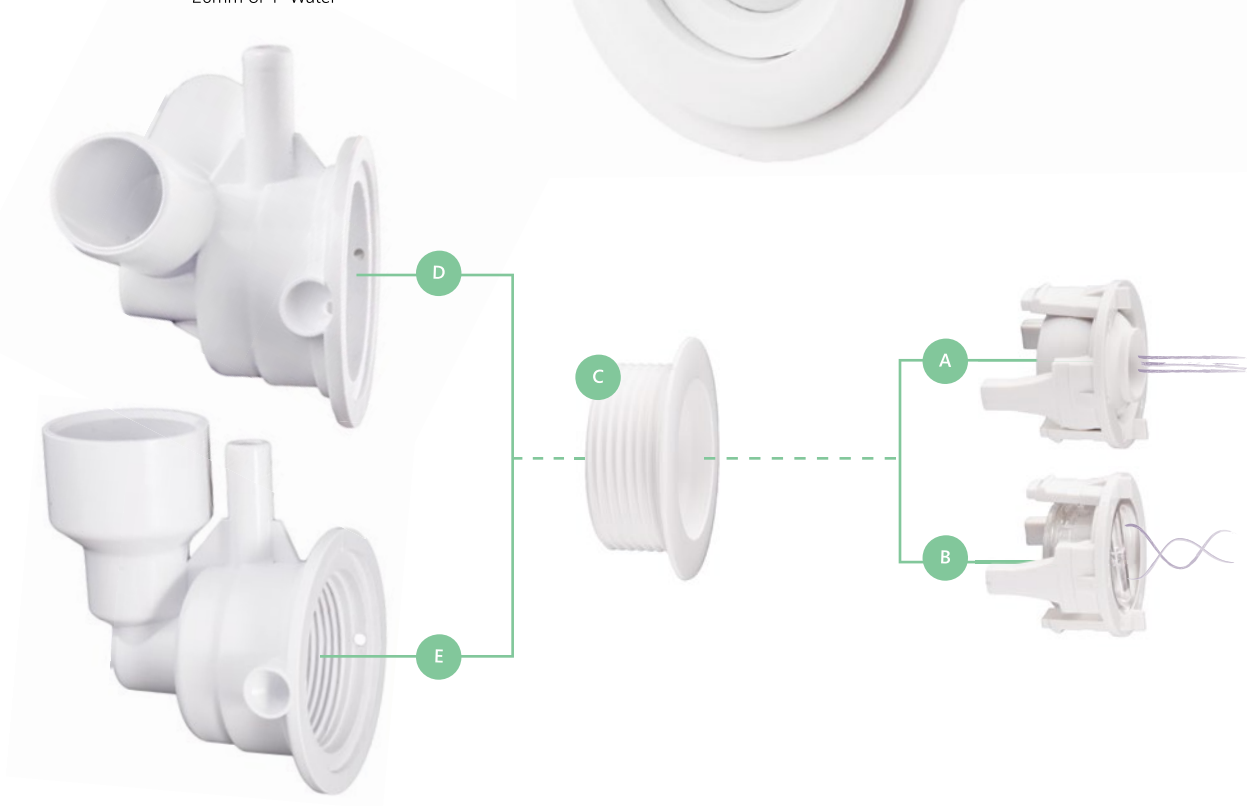

ORDERING GUIDE

REF	CMP P/N	DESCRIPTION	BOX QTY
SÖL SERIES TWO DECO ADJUSTABLE			
A	24100-000-900	SERIES TWO DECO ADJUSTABLE DIRECTIONAL NOZZLE INTERNAL, WHITE	50
B	24100-000-910	SERIES TWO DECO ADJUSTABLE ROTO NOZZLE INTERNAL, WHITE	50
C	24100-000-090	SERIES TWO DECO ADJUSTABLE JET WALL FITTING	100
D	24000-000-200	SERIES TWO 26MM ADJUSTABLE V-BODY	250
D	24100-000-200	SERIES TWO 1" ADJUSTABLE V-BODY	100
E	24100-000-220	SERIES TWO 1" ADJUSTABLE L-BODY	100
E	24000-000-220	SERIES TWO 26MM ADJUSTABLE L-BODY	100
—	24100-000-999	SERIES TWO WALL FITTING TOOL	—

SÖL BATH JETS

SERIES TWO: SMOOTH

PRODUCT FEATURES

- Adjustable Flow
- Smooth Face Design
- 2" Round Face
- Directional Flow
- Silicone Injection Ports
- "V" or "L" or Body

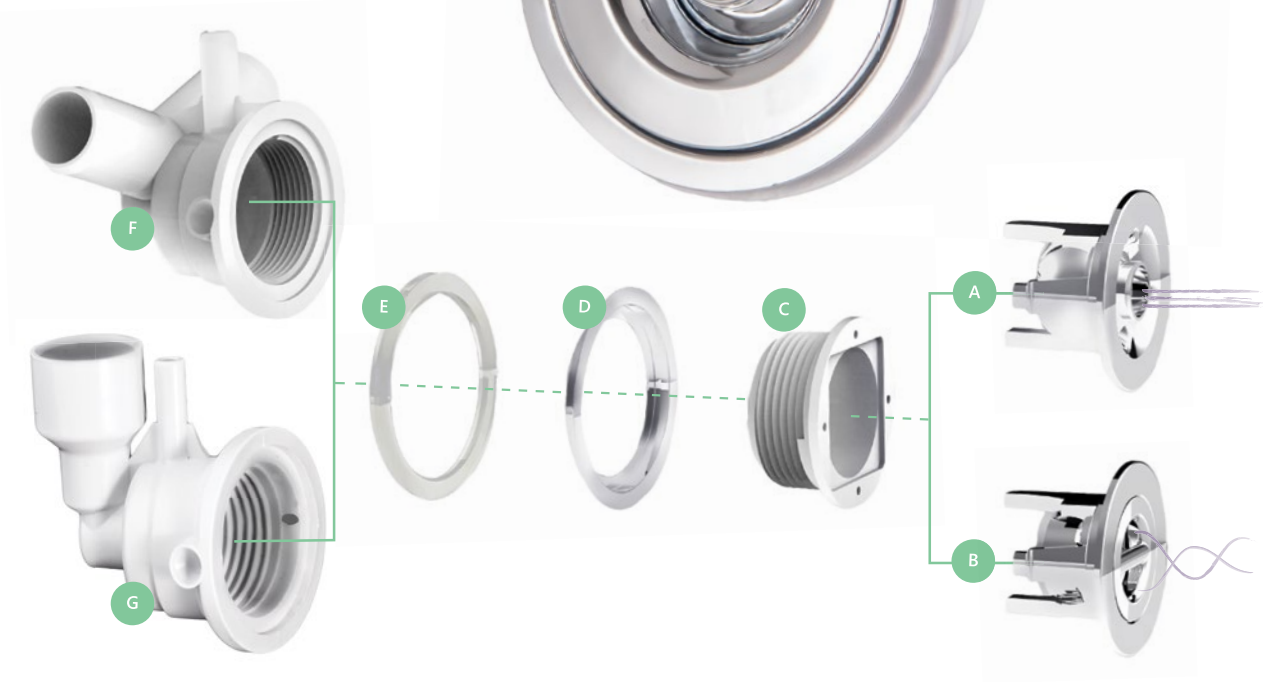
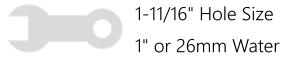

ORDERING GUIDE

REF	CMP P/N	DESCRIPTION	BOX QTY
SÖL SERIES TWO SMOOTH			
A	24100-500-000	SERIES TWO SMOOTH DIRECTIONAL JET INTERNAL	50
B	24100-500-100	SERIES TWO SMOOTH ROTO JET INTERNAL	50
C	24100-500-040	SERIES TWO SMOOTH WALL FITTING	100
D	24100-500-030	SERIES TWO SMOOTH WALL FITTING ESCUTCHEON (STAINLESS STEEL RING)	50
E	24100-500-070	SERIES TWO WALL FITTING GASKET	50
F	24000-000-200	SERIES TWO 26MM ADJUSTABLE V-BODY	250
—	24000-000-300	SERIES TWO 26MM ADJUSTABLE V-BODY WITH EXTENDED FLANGE	—
—	24000-000-305	SERIES TWO 26MM ADJUSTABLE V-BODY W/ EXTENDED FLANGE & CHECK VALVE	—
F	24100-000-200	SERIES TWO 1" ADJUSTABLE V-BODY	100
G	24000-000-220	SERIES TWO 26MM ADJUSTABLE L-BODY	100
—	24000-000-320	SERIES TWO 26MM ADJUSTABLE L-BODY WITH EXTENDED FLANGE	—
—	24000-000-325	SERIES TWO 26MM ADJUSTABLE L-BODY W/ EXTENDED FLANGE & CHECK VALVE	—
G	24100-000-220	SERIES TWO 1" ADJUSTABLE L-BODY	100
—	24100-999-999	WALL FITTING TOOL (100-E)	—

SÖL BATH JETS

SERIES TWO: SLOTTED

PRODUCT FEATURES

- Unique Slotted Jet
- Smooth Face Design
- Silicone Injection Ports
- "V" or "L" or Body
- Adjustable or Non-Adjustable Flow

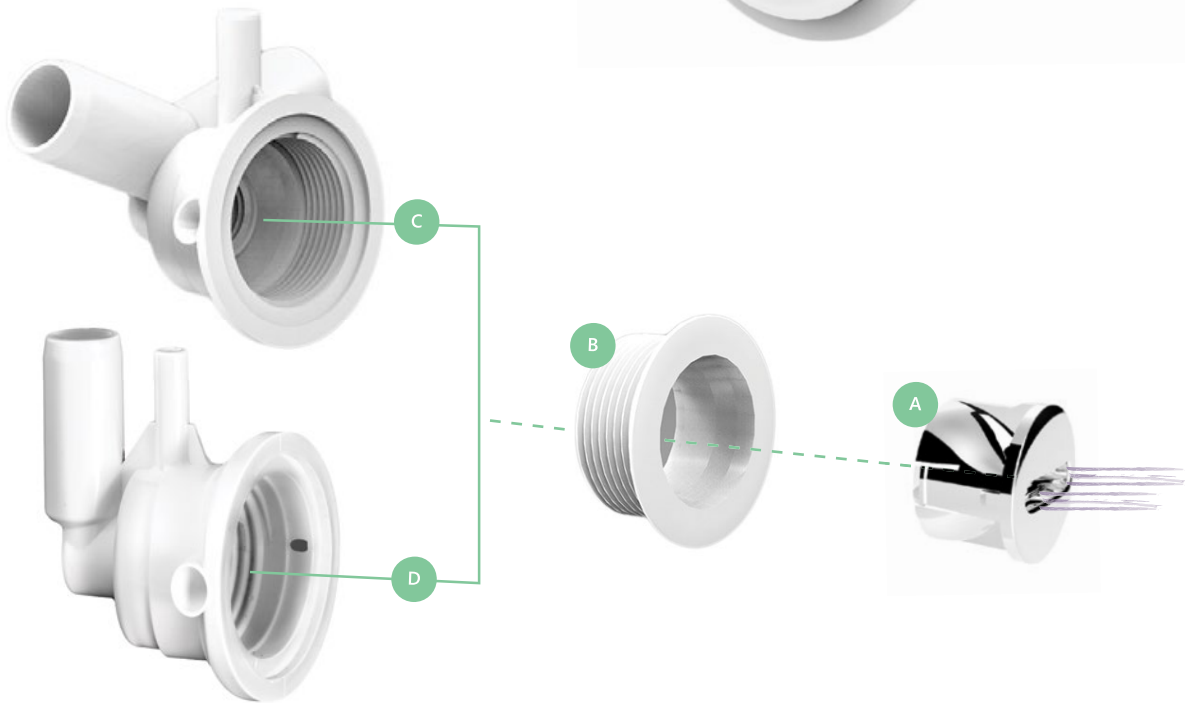
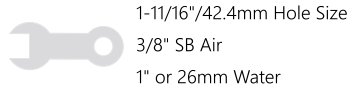

ORDERING GUIDE

REF	CMP P/N	DESCRIPTION	BOX QTY
SÖL SERIES TWO SLOTTED			
A	24100-000-094	SERIES TWO SLOTTED JET INTERNAL	50
B	24100-000-090	SERIES TWO SLOTTED WALL FITTING	100
C	24100-000-200	SERIES TWO 1" ADJUSTABLE V-BODY	100
C	24101-000-700	SERIES TWO SLOTTED 1" NON-ADJUSTABLE V-BODY	100
C	24000-000-200	SERIES TWO 26MM ADJUSTABLE V-BODY	250
C	24001-000-700	SERIES TWO SLOTTED 26MM NON-ADJUSTABLE V-BODY	100
D	24100-000-220	SERIES TWO 1" ADJUSTABLE L-BODY	100
D	24101-000-720	SERIES TWO SLOTTED 1" NON-ADJUSTABLE L-BODY	100
D	24000-000-220	SERIES TWO 26MM ADJUSTABLE L-BODY	100
D	24001-000-720	SERIES TWO SLOTTED 26MM NON-ADJUSTABLE L-BODY	100
—	24100-000-999	WALL FITTING TOOL	—

SÖL BATH JETS

MICRO SERIES

PRODUCT FEATURES

- Silicone Injection Ports
- "V" or "L" Body
- Uni-Directional or Roto Internal
- Flow Adjustable or Non-Adjustable Internals



1-1/2"/38.1mm Hole Size
 3/8" SB Air
 26mm or 3/4" Water

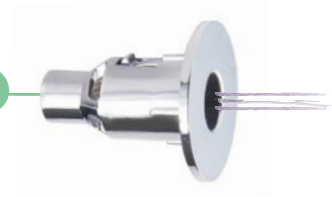

ORDERING GUIDE

REF	CMP P/N	DESCRIPTION*	BOX QTY
SÖL MICRO SERIES			
A	23400-800-100	1.25" MICRO FIXED JET INTERNAL, ADJUSTABLE	50
A	23400-800-000	1.25" MICRO FIXED JET INTERNAL, NON-ADJUSTABLE	50
B	23401-800-100	1.25" MICRO FIXED ROTO JET INTERNAL, ADJUSTABLE	50
B	23401-800-000	1.25" MICRO FIXED ROTO JET INTERNAL, NON-ADJUSTABLE	50
C	23400-800-010	1.25" MICRO ESCUTCHEON/TRIM RING	50
D	23400-840-040	1.25" MICRO WALL FITTING	100
E	23400-800-030	1.25" MICRO 26MM V-BODY WITH ADAPTER WITH CHECK VALVE	100
F	23400-900-080	1.25" MICRO 26MM L-JET BODY WITH ADAPTER WITH CHECK VALVE	100
F	23400-950-080	1.25" MICRO 3/4 SOCKET L-BODY WITH ADAPTER WITH CHECK VALVE	100
—	23400-999-999	TOOL FOR MICRO WALL FITTING	—

TECH SERIES JETS

TS-I JET

PRODUCT FEATURES

- Smooth Rounded Face
- Flow Control Nozzle
- Directional Nozzle
- Silicone Injection Ports
- "V" or "L" Jet Body

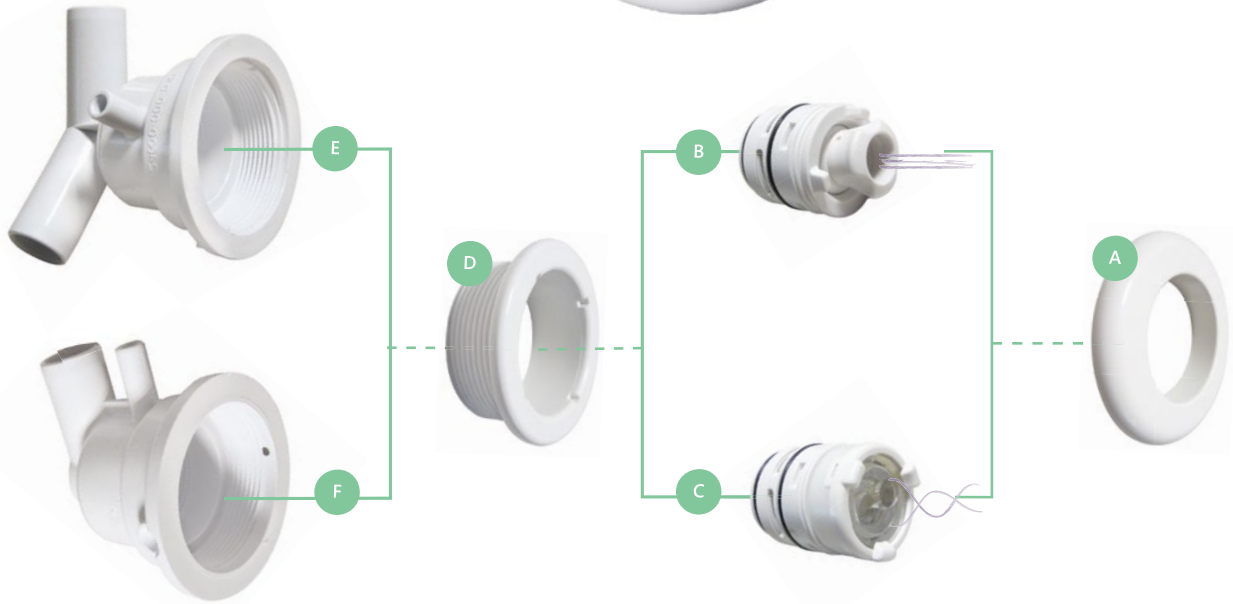
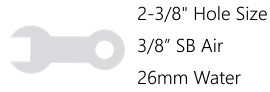

ORDERING GUIDE

REF	CMP P/N	DESCRIPTION	BAG/BOX
TECH SERIES TS-I JET			
A	24600-000-040	TS-I SMOOTH ESCUTCHEON	300
B	24600-000-000	TS-I DIRECTIONAL INTERNAL	400/100
C	24600-000-100	TS-I ROTATIONAL INTERNAL	400/100
D	24600-000-030	TS-I WALL FITTING	300
E	24600-000-010	TS-I "V" JET BODY	100
F	24600-000-020	TS-I "L" JET BODY	100
—	24600-999-999	TS-I TOOL FOR WALL FITTING	—
—	24600-399-999	TS-I TOOL FOR JET INTERNAL	—

TECH SERIES JETS

TS-II JET

PRODUCT FEATURES

- Smooth Flat Face
- Adjustable Flow
- Directional Nozzle
- Silicone Injection Ports



2-1/4" Hole Size
 3/8" SB Air
 26mm Water

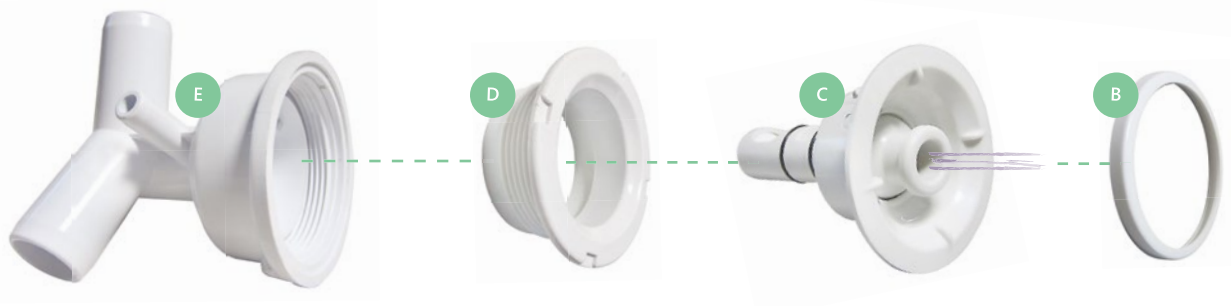

ORDERING GUIDE

REF	CMP P/N	DESCRIPTION	BOX QTY
TECH SERIES TS-II JET			
A	27270-900-000	TS-II COMPLETE DIRECTIONAL ASSEMBLY	80
B	27270-900-060	TS-II TRIM RING	100
C	27270-900-100	TS-II DIRECTIONAL JET INTERNAL	50
D	27270-900-050	TS-II WALL FITTING	100
E	27270-900-070	TS-II "V" JET BODY	100
—	27270-999-999	TS-II TOOL FOR WALL FITTING	—
—	27270-900-999	TS-II TOOL FOR JET INTERNAL	—

TECH SERIES JETS

TS-III JET

PRODUCT FEATURES

- Smooth Rounded Face
- Center Air Draw
- Adjustable Flow
- Directional Nozzle

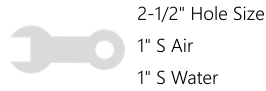

ORDERING GUIDE

REF	CMP P/N	DESCRIPTION	BOX/BAG
TECH SERIES TS-III JET			
A	23061-000-000	TS-III COMPLETE DIRECTIONAL ASSEMBLY	60
A	23061-002-000	TS-III COMPLETE CHROME DIRECTIONAL ASSEMBLY	60
A	23061-000-133	TS-III COMPLETE BRASS DIRECTIONAL ASSEMBLY	60
B	23061-010-000	TS-III ESCUTCHEON/WALL FITTING	200/20
C	26200-230-601	TS-III GASKET	60
D	23061-000-100	TS-III NOZZLE & RING	60
D	23061-132-002	TS-III CHROME NOZZLE & RING	60
D	23061-132-003	TS-III BRASS NOZZLE & RING	60
E	23061-000-200	TS-III JET BODY ASSEMBLY	60
F	21022-000-000	1" PLUG (SOLD SEPARATELY)	500/25
—	27112-000-000	TS-III PLASTIC TOOL FOR JET	—
—	23061-999-999	TS-III METAL TOOL FOR JET	—
—	23061-090-000	RETAINING RING	—

TECH SERIES JETS

TS-IV JET

PRODUCT FEATURES

- Rounded Face Design
- Adjustable Flow
- Silicone Injection Ports
- Directional Nozzle

- 2-3/8" Hole Size
- 3/8" SB Air
- 1" S Water

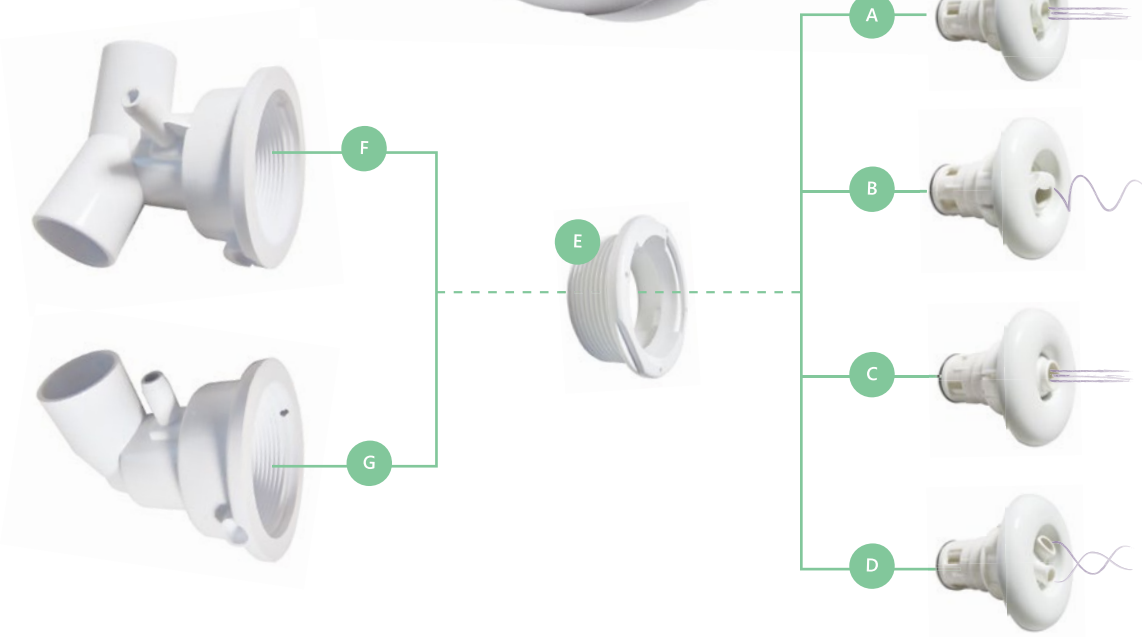

ORDERING GUIDE

REF	CMP P/N	DESCRIPTION	BOX QTY
TECH SERIES TS-IV JET			
A	27272-300-100	TS-IV SMOOTH ESCUTCHEON & DIRECTIONAL EYEBALL INTERNAL	240
B	27272-300-120	TS-IV SMOOTH ESCUTCHEON & SINGLE ROTO EYEBALL INTERNAL	240
C	27270-400-000	TS-IV ROUND ESCUTCHEON & DIRECTIONAL EYEBALL INTERNAL	240
D	27270-400-100	TS-IV ROUND ESCUTCHEON & DOUBLE ROTO EYEBALL INTERNAL	100
E	27270-300-040	TS-IV WALL FITTING	200
F	27272-300-200	TS-IV "V" JET BODY	100
G	27270-400-500	TS-IV "L" JET BODY	240
—	27270-399-999	TS-IV TOOL FOR WALL FITTING	—

TECH SERIES JETS

TS-V JET

PRODUCT FEATURES

- Scalloped Face Design
- Adjustable Flow
- Air Inlet
- Directional Nozzle



2-9/16" Hole Size
3/8" SB Air
26mm Water

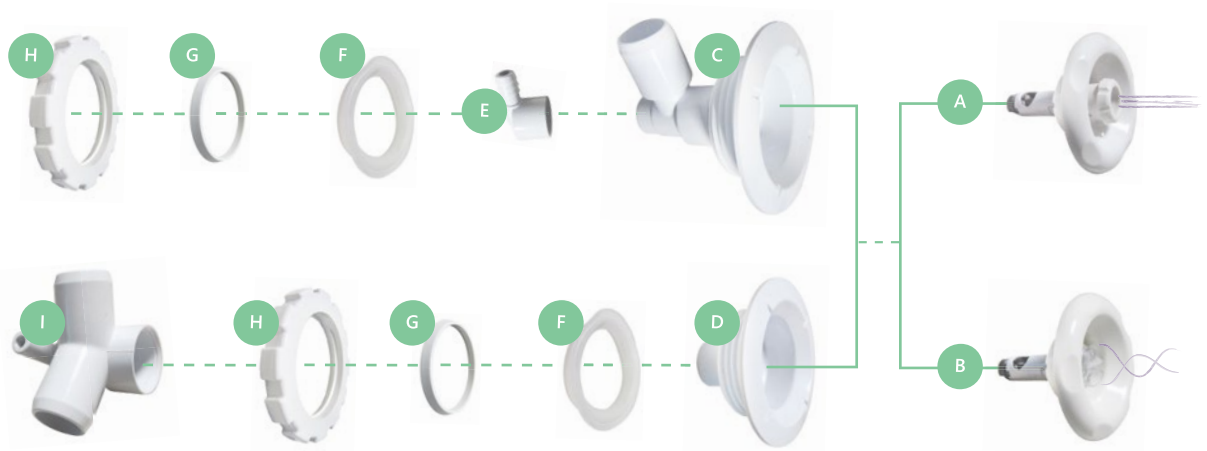

ORDERING GUIDE

REF	CMP P/N	DESCRIPTION	BOX/BAG
TECH SERIES TS-V JET			
A	24400-100-000	TS-V DIRECTIONAL INTERNAL & ESCUTCHEON	300
B	24401-100-000	TS-V DOUBLE ROTO INTERNAL & ESCUTCHEON	300
C	24400-000-000	TS-V "L" JET BODY	300
D	24400-000-004	TS-V WALL FITTING	500/50
E	24400-000-006	TS-V 3/8" AIR BARB FOR "L" JET BODY	2400
F	24400-000-008	TS-V "L" GASKET	1200
G	24400-000-007	TS-V COMPENSATOR RING	1800
H	24400-000-005	TS-V NUT	600
I	24400-000-001	TS-V "V" JET BODY	400
—	24400-999-999	TS-V TOOL FOR JET NUT	—

ECON SERIES JETS

100-E JET

PRODUCT FEATURES

- Five Face Design Options
- Adjustable or Non-Adjustable Flow
- Silicone Injection Ports
- CSA Certified

- 1-2/3" Hole Size
- 3/8" S. Barb Air × 1" Water
- 3/8" S. Barb Air × 26mm Water

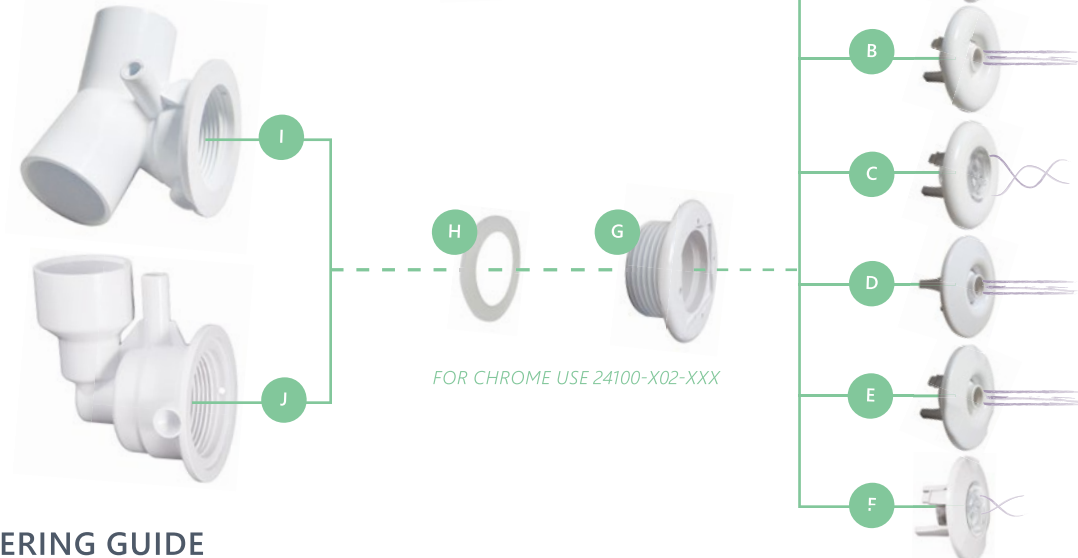

ORDERING GUIDE

REF	CMP P/N	DESCRIPTION	BOX/BAG
ECON SERIES 100-E JET			
A	24100-000-100	100-E SWIRL ESCUTCHEON DIRECTIONAL EYEBALL	1000/100
B	24100-000-300	100-E ROUND ESCUTCHEON DIRECTIONAL EYEBALL	1000/100
B	24100-000-500	100-E ROUND ESCUTCHEON DIR EYEBALL W/ EXTENDED LEGS FOR THICK TUBS	1000/100
C	24100-000-400	100-E ROUND ESCUTCHEON ROTO EYEBALL	100
C	24100-000-800	100-E ROUND ESCUTCHEON ROTO EYEBALL W/ EXTENDED LEGS FOR THICK TUBS	100
D	24100-100-100	100-E SMOOTH ESCUTCHEON DIRECTIONAL EYEBALL	100
E	24100-900-000	100-E 3-SCALLOP ESCUTCHEON DIRECTIONAL EYEBALL	800/100
F	24100-900-400	100-E 3-SCALLOP ESCUTCHEON AND ROTO EYEBALL	—
G	24100-000-040	100-E WALL FITTING	600/50
G	24100-000-052	100-E EXTENDED WALL FITTING FOR THICK TUB WALLS	600/50
H	24100-000-070	100-E GASKET	800
I	24100-000-200	1" V-BODY, ADJUSTABLE	100
I	24101-000-200	1" V-BODY, NON-ADJUSTABLE	100
I	24000-000-200	26MM V-BODY, ADJUSTABLE	250
I	24000-000-205	26MM V-BODY ADJUSTABLE WITH CHECK VALVE	—
I	24001-000-200	26MM V-BODY, NON-ADJUSTABLE	100
J	24100-000-220	1" L-BODY, ADJUSTABLE	100
J	24101-000-220	1" L-BODY, NON-ADJUSTABLE	100
J	24000-000-220	26MM L-BODY, ADJUSTABLE	100
J	24000-000-225	26MM L-BODY, ADJUSTABLE WITH CHECK VALVE	—
J	24001-000-220	26MM L-BODY, NON-ADJUSTABLE	100
—	24100-999-999	100-E TOOL FOR WALL FITTING	—

ECON SERIES JETS

200-E JET

PRODUCT FEATURES

- Smooth Face
- Adjustable Flow
- Directional Nozzle

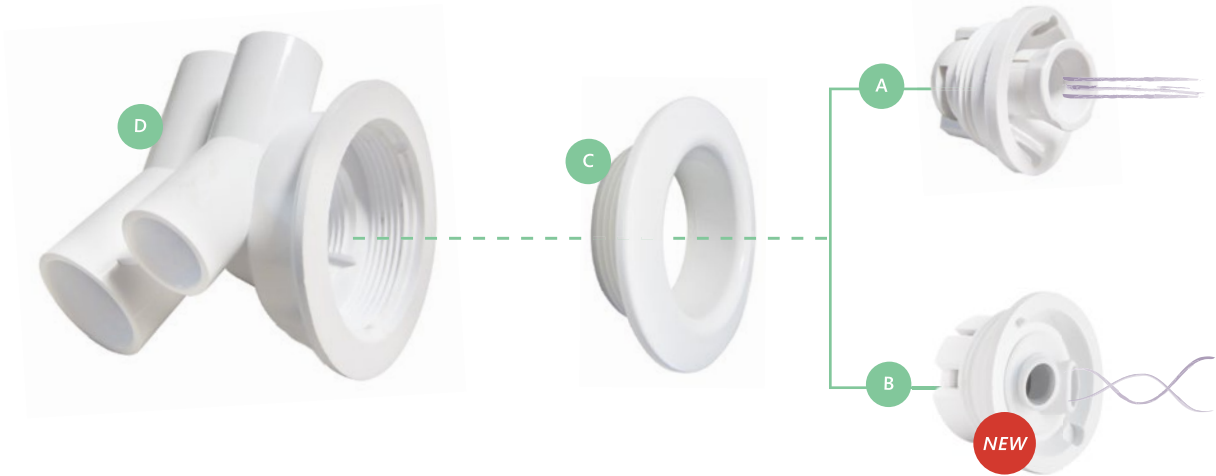
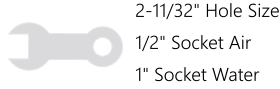

ORDERING GUIDE

REF	CMP P/N	DESCRIPTION	BOX QTY
ECON SERIES 200-E JET			
A	24300-200-000	200-E DIRECTIONAL NOZZLE ASSEMBLY	600
B	24302-000-000	200-E DOUBLE ROTO INTERNAL, WHITE	—
C	24300-300-000	200-E WALL FITTING	300
D	24300-100-000	200-E "V" JET BODY	100
D	24300-100-100	200-E "V" JET BODY WITH NO DRAIN CHANNEL	100
D	24300-100-200	200-E "V" JET SHORT BODY	—
D	24300-100-300	200-E "V" JET SHORT BODY WITH NO DRAIN CHANNEL	—
—	24300-000-070	200-E GASKET FOR DRAIN CHANNEL	200
—	24300-299-999	200-E NOZZLE ASSEMBLY WRENCH	—
—	24300-799-999	200-E COMBO WALL FITTING AND INTERNAL TOOL	—

ECON SERIES JETS

300-E JET

PRODUCT FEATURES

- Rounded Face Design
- Non-Adjustable Flow
- Directional Nozzle



1-11/16" Hole Size
 1/2" Socket Air
 1" Socket Water

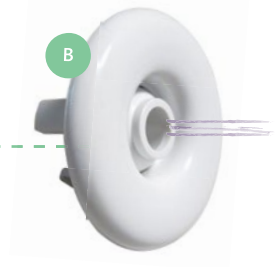
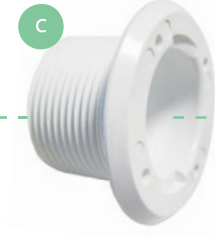

ORDERING GUIDE

REF	CMP P/N	DESCRIPTION	BOX QTY
ECON SERIES 300-E JET			
A	23071-000-000	300-E DIRECTIONAL ASSEMBLY	100
B	23071-000-100	300-E ESCUTCHEON & EYEBALL INSERT	100
C	23071-030-000	300-E WALL FITTING	100
D	26205-804-330	300-E GASKET	100
E	23071-000-200	300-E STRAIGHT JET BODY	100
—	23072-000-000	300-E TOOL FOR WALL FITTING	—

ECON SERIES JETS

300-EA JET

PRODUCT FEATURES

- Rounded or 3-Scallop Eyeball
- Directional Nozzle
- Adjustable Flow



1-11/16" Hole Size
1/2" Socket Air
1" Socket Water



ORDERING GUIDE

REF	CMP P/N	DESCRIPTION	BOX QTY
ECON SERIES 300-EA JET			
A	23070-000-000	300-EA DIRECTIONAL ASSEMBLY	120
A	23070-200-000	300-EA "V" JET DIRECTIONAL ASSEMBLY	120
B	23070-000-100	300-EA ESCUTCHEON & EYEBALL INSERT	100
C	23070-030-000	300-EA WALL FITTING	100
D	24100-900-000	100-E 3-SCALLOP ESCUTCHEON DIRECTIONAL EYEBALL	800/100
E	23070-130-000	300-EA WALL FITTING FOR 3-SCALLOP ESCUTCHEON DIRECTIONAL EYEBALL	600/50
F	26205-804-330	300-EA GASKET	100
G	23070-000-200	300-EA STRAIGHT JET BODY	100
—	23070-000-220	300-EA JET INTERNAL ONLY WITH STAR ORIFICE	—
H	23070-200-200	300-EA "V" JET BODY	100
—	23072-000-000	300-EA TOOL FOR WALL FITTING	800/100
—	24100-999-999	100-E 3-SCALLOP ESCUTCHEON WALL FITTING TOOL	—

ECON SERIES JETS

400-E JET

PRODUCT FEATURES

- Rounded Face Design
- Non-Adjustable



1-11/16" Hole Size

1" Socket Air

1" Socket Water

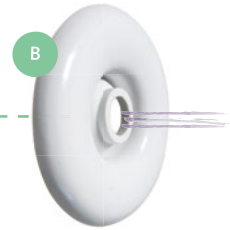
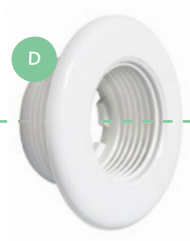

ORDERING GUIDE

REF	CMP P/N	DESCRIPTION	BOX QTY
ECON SERIES 400-E JET			
A	23062-000-000	400-E COMPLETE DIRECTIONAL ASSEMBLY	100
B	23062-000-100	400-E ESCUTCHEON & EYEBALL	100
C	23062-050-000	400-E EYEBALL RETAINER RING	50
D	23062-020-000	400-E WALL FITTING	100
E	26205-554-230	400-E GASKET	100
F	23062-000-200	400-E JET BODY & O-RING	100
—	23062-999-999	400-E TOOL FOR WALL FITTING	—

ECON SERIES JETS

500-E JET

PRODUCT FEATURES

- Traditional 5-Scallop Design
- Adjustable Flow
- Silicone Injection Ports



2-1/8" Hole Size

1/2" Socket Air

1" Socket Water

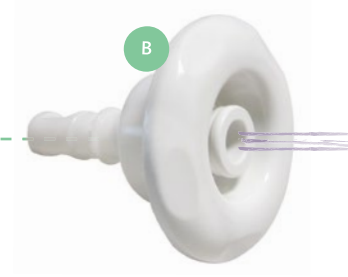

ORDERING GUIDE

REF	CMP P/N	DESCRIPTION	BOX QTY
ECON SERIES 500-E JET			
A	27270-000-000	500-E COMPLETE DIRECTIONAL ASSEMBLY	100
B	27270-100-200	500-E 5-SCALLOP ESCUTCHEON & EYEBALL INSERT	100
C	27270-100-050	500-E WALL FITTING	100
D	27270-200-000	500-E JET BODY	100

BATH SERIES JETS

3" BATH SERIES

PRODUCT FEATURES

- Rounded Face
- Adjustable Flow
- Directional Nozzle

- 2-3/16" Hole Size
- 3/8" SB Air
- 3/4" S Water
- 1" SP / 26mm SP Water

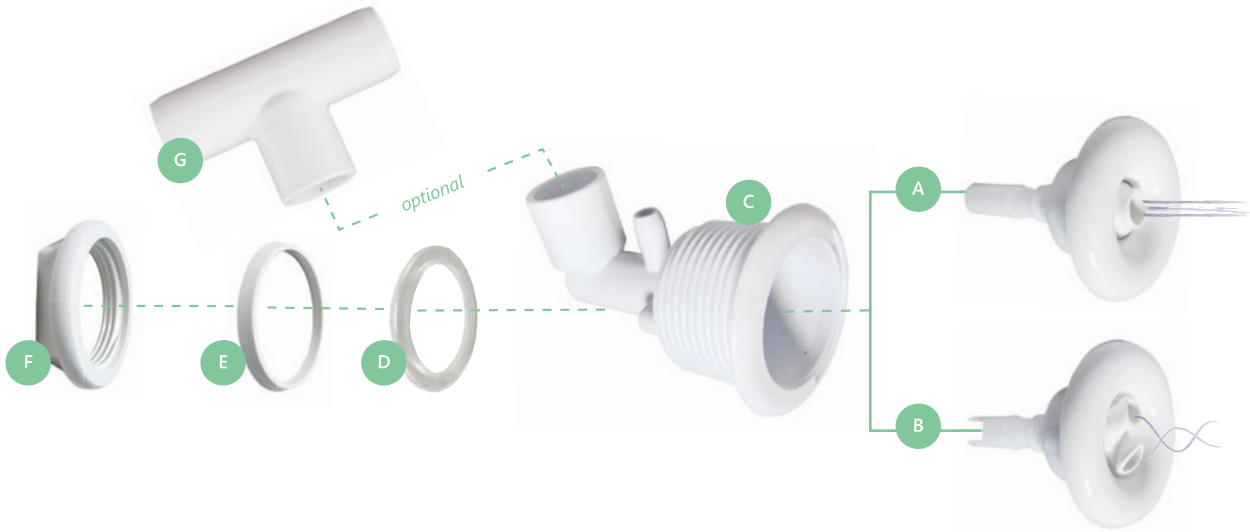

ORDERING GUIDE

REF	CMP P/N	DESCRIPTION	BOX QTY
3" BATH SERIES JET			
A	23432-500-000	3" ROUND ESCUTCHEON AND DIRECTIONAL INTERNAL	50
B	23432-500-100	3" ROUND ESCUTCHEON AND ROTATIONAL INTERNAL	50
C	23432-500-500	3" "L" JET BODY	100
D	23432-000-050	3" "L" GASKET	100
E	23432-000-010	3" COMPENSATOR RING	100
F	23432-000-040	3" NUT FOR JET BODY	100
G	24202-126-000	3/4" SLIP TO 26MM TEE ADAPTER	100
—	23432-999-999	3" TOOL FOR JET NUT	—

BATH SERIES JETS

3" BATH SERIES (100% SHUT-OFF)

PRODUCT FEATURES

- Rounded Face
- 100% Shut-Off Capable
- Adjustable Flow
- Directional Nozzle



2-3/16" Hole Size
3/4" S Water
1" SP / 26mm SP Water

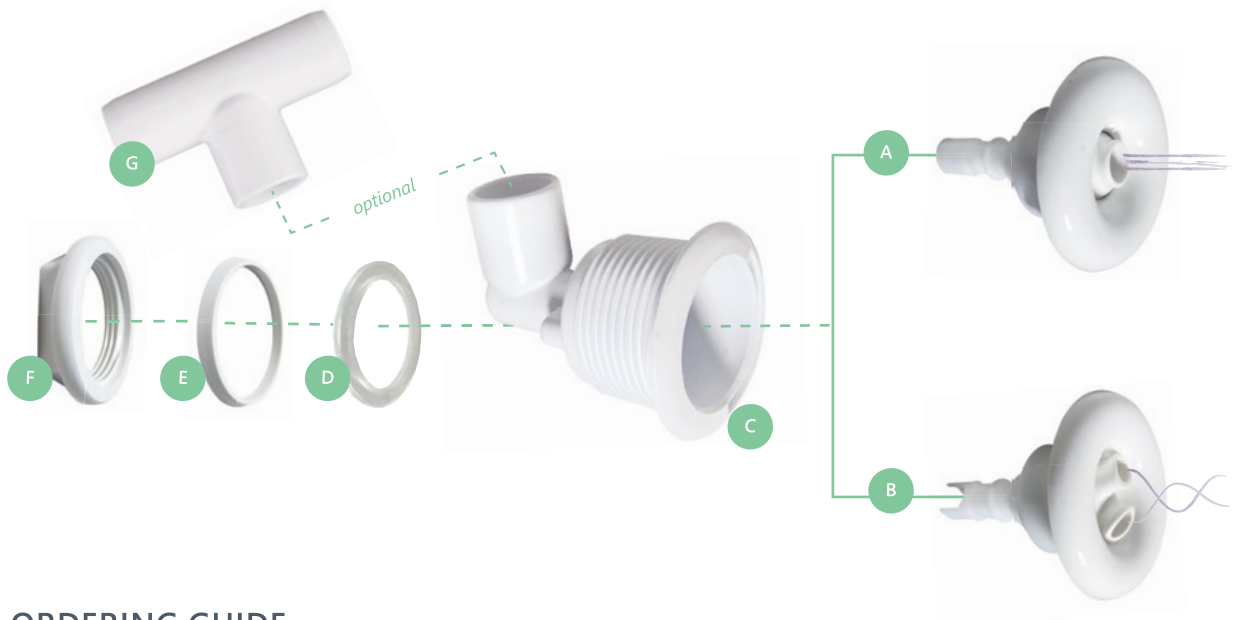

ORDERING GUIDE

REF	CMP P/N	DESCRIPTION	BOX QTY
3" BATH SERIES JET (100% SHUT-OFF)			
A	23432-700-000	3" SHUT-OFF ROUND ESCUTCHEON AND DIRECTIONAL INTERNAL	50
B	23432-700-100	3" SHUT-OFF ROUND ESCUTCHEON AND ROTATIONAL INTERNAL	50
C	23432-700-500	3" SHUT-OFF "L" JET BODY	100
D	23432-000-050	3" "L" GASKET	100
E	23432-000-010	3" COMPENSATOR RING	500
F	23432-000-040	3" NUT FOR JET BODY	100
G	24202-126-000	3/4" SLIP TO 26MM TEE ADAPTER	100
—	23432-999-999	3" TOOL FOR JET NUT	—

BATH SERIES JETS

2" BATH SERIES

PRODUCT FEATURES

- Rounded Face
- Adjustable Flow
- Uni-Directional Nozzle



1-1/2" Hole Size
 3/8" SB Air
 3/4" S Water
 1" SP / 26mm SP Water

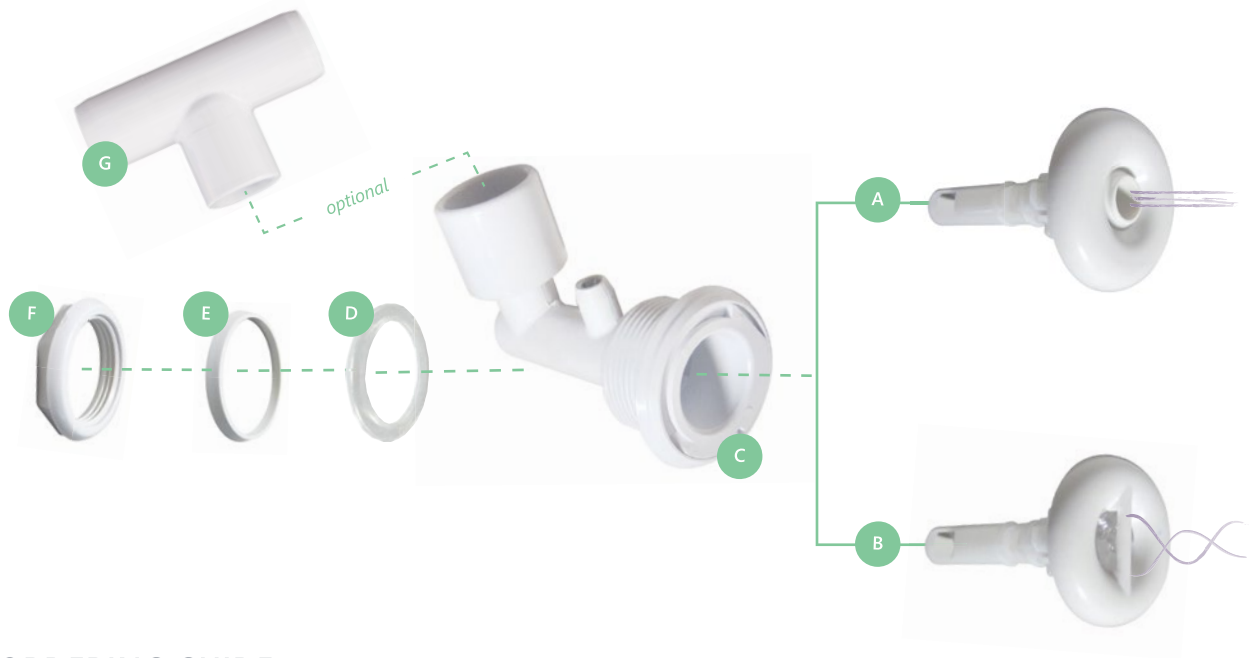

ORDERING GUIDE

REF	CMP P/N	DESCRIPTION	BOX/BAG
2" BATH SERIES JET			
A	23422-500-000	2" ROUND ESCUTCHEON AND DIRECTIONAL INTERNAL	50
B	23422-500-100	2" ROUND ESCUTCHEON AND ROTATIONAL INTERNAL	50
C	23422-500-500	2" "L" JET BODY	100
D	23422-000-050	2" "L" GASKET	100
E	23422-000-010	2" COMPENSATOR RING	100
F	23422-000-040	2" NUT FOR JET BODY	100
G	24202-126-000	3/4" SLIP TO 26MM TEE ADAPTER	100
—	23422-999-999	2" TOOL FOR JET NUT	—

MINI JETS

MICRO JET

PRODUCT FEATURES

- Adjustable Flow
- Silicone Injection Ports
- Directional or Roto Nozzle

 1-9/64" Hole Size
3/8" Air
26mm" or 3/4" Water

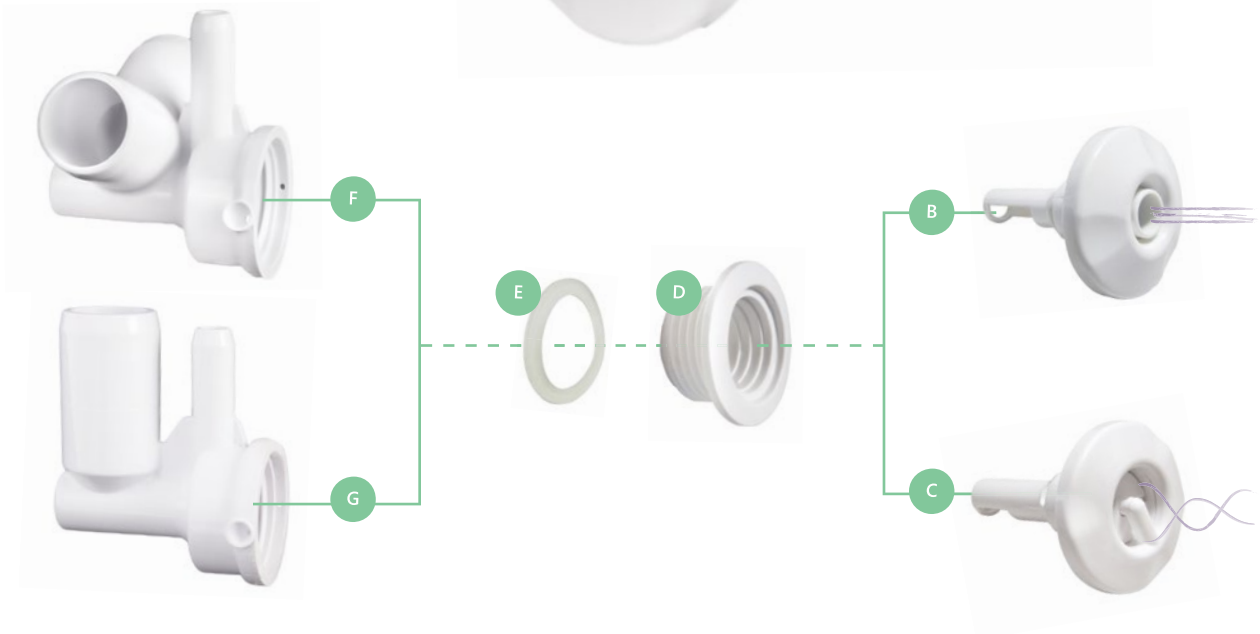

ORDERING GUIDE

REF	CMP P/N	DESCRIPTION	BOX/BAG
MICRO JET			
A	23401-900-000	MICRO JET ROTATIONAL ASSEMBLY (PICTURED)	120
A	23400-900-000	MICRO JET DIRECTIONAL ASSEMBLY	120
B	23400-900-100	MICRO JET 3-SCALLOP & DIRECTIONAL EYEBALL INSERT	50
C	23401-900-100	MICRO JET 3-SCALLOP & ROTATIONAL EYEBALL INSERT	50
D	23400-940-040	MICRO JET WALL FITTING	100
E	23400-900-050	MICRO JET GASKET	100
F	23400-900-030	26MM MICRO JET V-BODY, ADJUSTABLE WITH CHECK VALVE	100
G	23400-900-060	26MM MICRO JET L-BODY, ADJUSTABLE WITH CHECK VALVE	100
G	23400-950-060	26MM MICRO JET L-BODY, ADJUSTABLE	100
—	23400-999-999	MICRO V TOOL FOR WALL FITTING	—

MINI JETS

EURO JETS



PRODUCT FEATURES

- Low Profile Design Allows for Multiple Plumbing Variations
- Non-Adjustable
- Directional, Rotational and Uni-Directional Nozzles

 15/16" Hole Size
CSA Approval

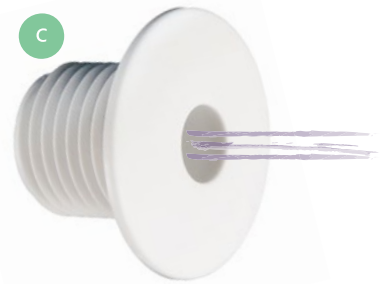

ORDERING GUIDE

REF	CMP P/N	DESCRIPTION	BOX/BAG
EURO JETS			
A	24500-900-000	1-5/8" DIRECTIONAL SMOOTH FACE EURO JET	1000/50
B	24510-900-000	1-5/8" ROTATIONAL SMOOTH FACE EURO JET	1000/50
C	24522-000-000	1-1/2" UNI-DIRECTIONAL SMOOTH FACE EURO JET	1000/50
D	23500-300-000	1-5/8" ROTATIONAL ROUNDED FACE EURO JET	1000/50
E	24530-000-000	2" UNI-DIRECTIONAL SMOOTH FACE EURO JET	1000/50
F	24500-999-999	EURO JET WALL FITTING TOOL	—

MINI JETS

EURO JET BODIES

PRODUCT FEATURES

- 3/8" and 1/2" Water Connections
- Fits all Euro Jet Internal Styles
- CSA Certified Options



ORDERING GUIDE

REF	CMP P/N	DESCRIPTION	BOX/BAG
EURO JET BODIES			
A	23400-400-060	1/2" SPIGOT WATER × 3/8" RIBBED BARB AIR	1000/50
A	23400-400-030	1/2" SPIGOT WATER × 3/8" RIBBED BARB AIR WITH SILICONE PORTS	1000/50
B	23400-500-000	3/8" RIBBED BARB WATER	1000/50
C	23400-600-000	1/2" SPIGOT WATER, NO AIR	1000/50
FITTINGS & ACCESSORIES			
D	21042-600-000	26MM BARB TEE FITTING	1000/50
E	21034-600-000	26MM BARB ELL FITTING	1000/50
F	21042-900-000	26MM "V" ADAPTER	400/50
G	26203-202-215	EURO JET CLEAR GASKET	1000/50

BATH DESIGN INFOGRAPHIC

HOSE & TUBING REFERENCE

(see page 77)

- 1.5" Tubing
- 3/8" Air Line
- Flex Tubing
- Air Button Tubing

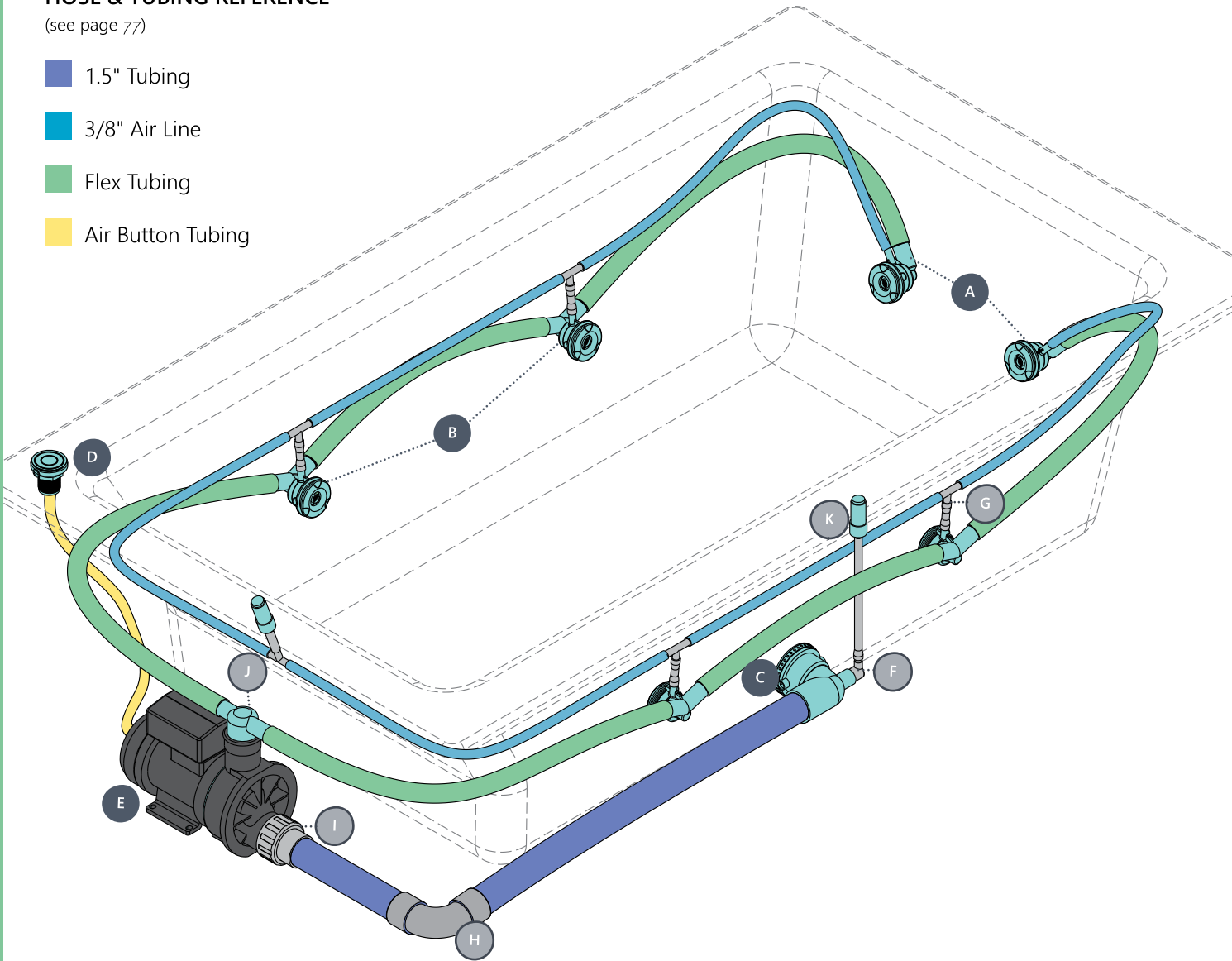

DIAGRAM GUIDE

REF	DESCRIPTION	PAGE
BATH COMPONENTS		
A	100-E "L" JET BODY	22
B	100-E "V" JET BODY	22
C	110 GPM LOW PROFILE SUCTION	72
D	SLIM AIR BUTTON	63
E	NEXXUS II PUMP, TOP DISCHARGE	54

REF	DESCRIPTION	PAGE
WHITE GOODS		
F	ELL BARB	76
G	3/8" TEE	76
H	1.5" SWEEP 90	74
I	PUMP TEE UNION	75
J	PUMP TEE UNION	75
K	CHECK VALVE	75

Caresse

A REVOLUTIONARY BATHING EXPERIENCE

The Caresse® silent therapy system creates a complete escape with natural, gentle relaxing motion.

The innovative patent-pending design creates a soothing style of water therapy using the unique vented jet design. Unlike turbulent air and water jets, Caresse gently wraps your body in ribbons of warm water.

Gentle flow combined with relaxing heat and LED chromatherapy; Caresse® enhances your body, mind and spirit.

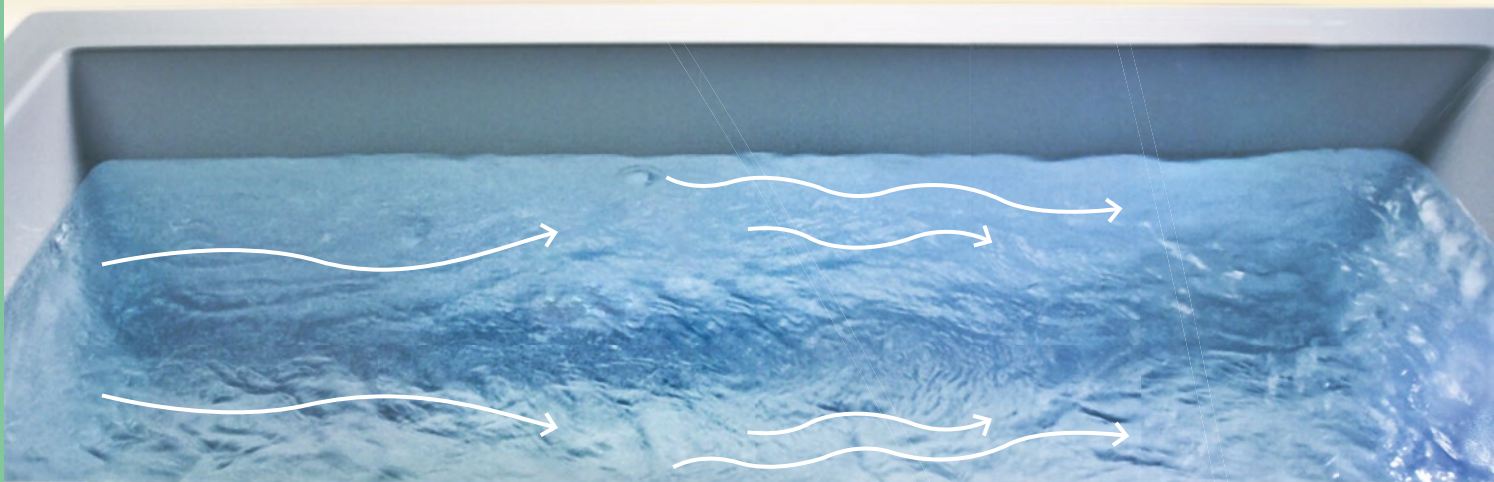

Caresse® gently wraps your body in ribbons of warm water.

GENTLE THERAPY

Caresse® end and side vents create a swirling, layered current throughout the bath. The warm, gentle and natural flow of water relaxes muscles, increases blood flow, and relieves stress.

CARESSE® END JET VENTS

End Vents create ribbons of water that flow over the top and front of your body.

CARESSE® SIDE JET VENTS

Side Vents envelop your body and can be adjusted to create unique flow patterns.



A. ADJUSTABILITY

Caresse® side vents can be rotated to any position you desire. Direct ribbons of water along your body and drift away, or adjust the flow direction to create a soothing swirl of water.

B. WATER MOVEMENT ONLY

Without air to agitate, the smooth ribbon-like flow of water is gentle and silent.

Caresse®

WHERE WILL YOUR BATHING RITUAL TAKE YOU?™

CARESSE® SYSTEM

CARESSE® JETS

PRODUCT FEATURES

- Silicone Injection Ports
- Gentle Water Flow
- Non-Adjustable Flow

 1-11/16"/42.4mm Hole Size
3/8" Air
26mm" Water

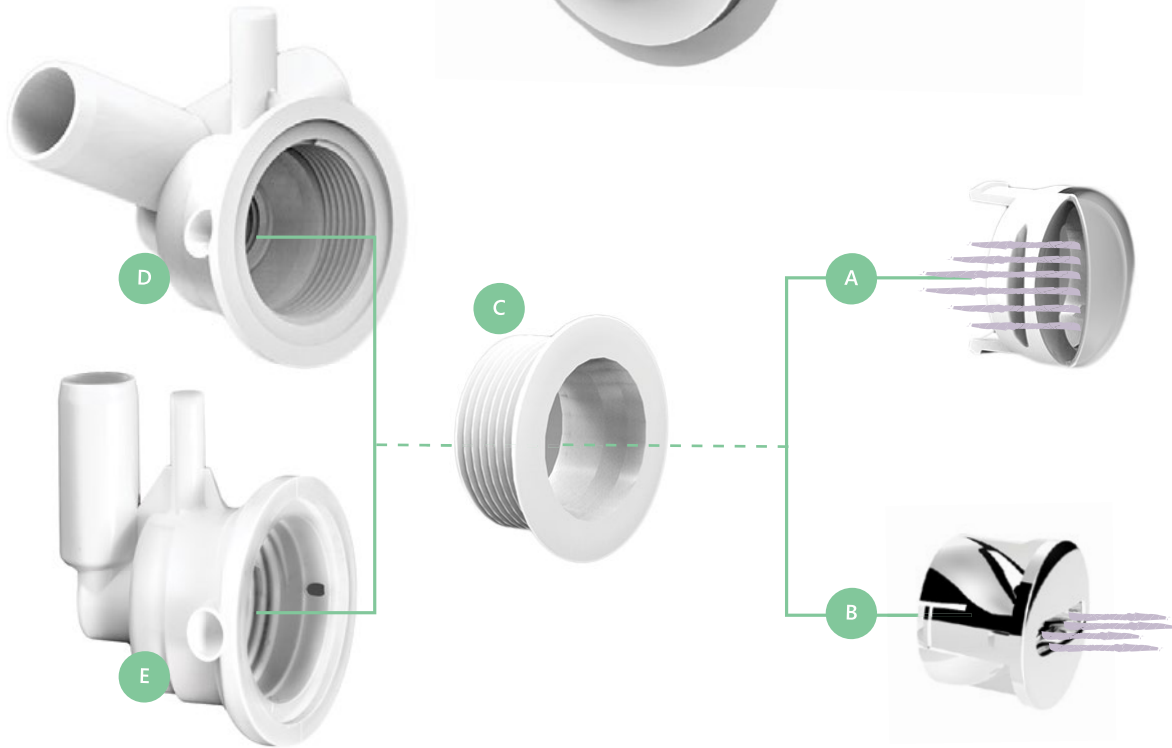

ORDERING GUIDE

REF	CMP P/N	DESCRIPTION	BOX/BAG
CARESSE® JETS			
A	24100-000-081	CARESSE® SIDE JET INTERNAL	100
B	24100-000-094	CARESSE® SLOTTED JET INTERNAL	100
C	24100-000-090	CARESSE® WALL FITTING	100
D	24001-000-211	26MM V-BODY WITH 3/8" PLUG, NON-ADJUSTABLE	100
D	24100-000-211	1" V-BODY WITH 3/8" PLUG, NON-ADJUSTABLE	100
E	24001-000-221	26MM L-BODY WITH 3/8" PLUG, NON-ADJUSTABLE	100
E	24101-000-221	1" L-BODY WITH 3/8" PLUG, NON-ADJUSTABLE	100
—	27240-148-000	NEXXUS Q PUMP, 120V (US)	—
—	27240-248-000	NEXXUS Q PUMP, 220V (EUROPE)	—
—	24100-000-999	WALL FITTING TOOL	—

CARESSE® SYSTEM DESIGN INFOGRAPHIC

HOSE & TUBING REFERENCE

(see page 77)

- 1.5" Tubing
- Flex Tubing
- Air Button Tubing

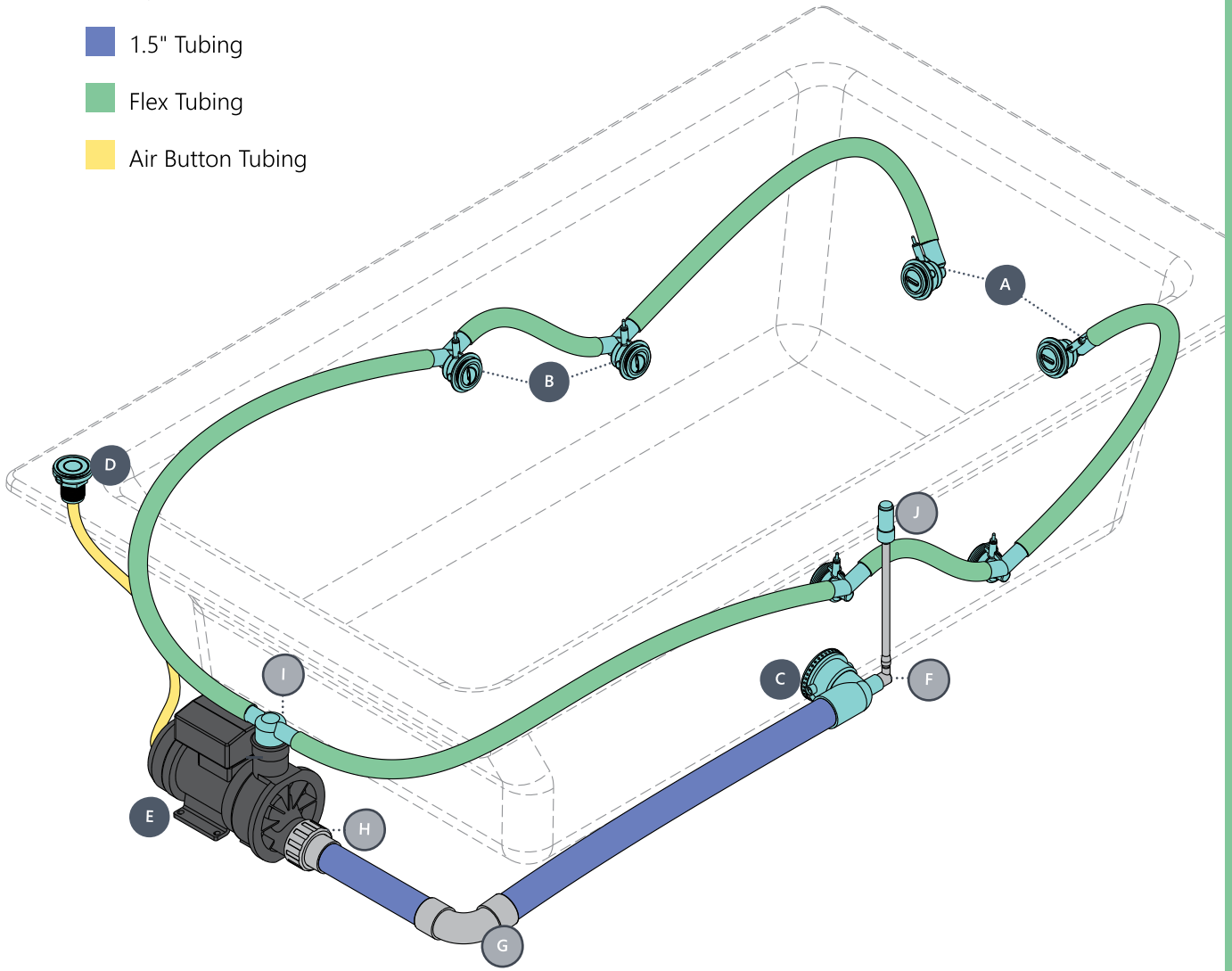

DIAGRAM GUIDE

REF	DESCRIPTION	PAGE
CARESSE SYSTEM COMPONENTS		
A	CARESSE SLOTTED "L" JET	38
B	CARESSE SIDE JET WITH "V" BODY	38
C	110 GPM LOW PROFILE SUCTION	72
D	SLIM AIR BUTTON	63
E	NEXXUS Q PUMP	38

REF	DESCRIPTION	PAGE
WHITE GOODS		
F	ELL BARB	76
G	1.5" SWEEP 90	74
H	PUMP UNION	75
I	PUMP TEE UNION	75
J	CHECK VALVE	75

BATH CONTROLS & EQUIPMENT

NEXXUS™ CONTROLS *42*

NEXXUS™ PUMPS *54*

NEXXUS™ DH HEATERS *58*

NEXXUS™ AIR BLOWERS *59*

Nexxus™

BATH CONTROLS

NEW

- Complete Suite of Expandable Bath Controls
- Custom Programming Options
- Capacitive Touch Buttons: No Moving Parts
- Solenoid Control Capabilities
- Chrome or White Bezels



Nexus™ Bath Controls from CMP offer a full suite of options for whirlpool bath control. This complete collection includes programmable LCD style controls and "basic" options in one to six button sizes.

NEXXUS™ LCD SERIES

- Interactive LCD Feedback Screen
- Programmable Functions
- Four and Two Button Options
- Solenoid Capabilities

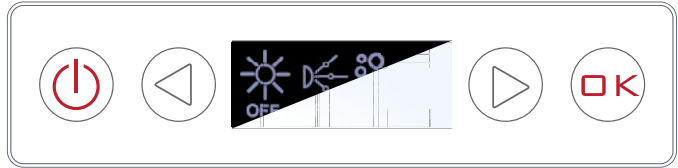

NEXXUS™ TOUCH SERIES

- Six and Four Button Configurations
- Capacitive Touch Buttons
- Pump, Blower, Light & Lock Operations
- Seven Available Functions

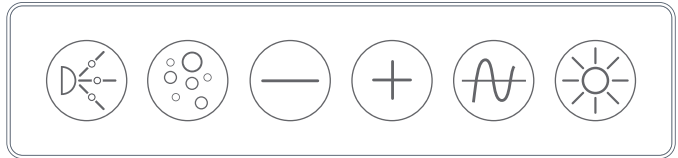

NEXXUS™ TOUCH SERIES; ROUND

- Single and Three Button Options
- Simple, Compact Round Controls
- Capacitive Touch Buttons
- Economical Choices
- Three Available Functions

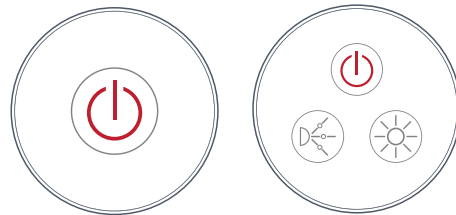

COMPLETE NEXXUS™ CONTROL SYSTEM

PRODUCT FEATURES

- Flexible, Expandable System Design
- Labeled Cord Connections for Easy Installation and Troubleshooting
- Multiple B4 Solenoid Controllers Can Be Used with Slave Connection

DIGITAL CONTROL SYSTEM (B1,B2,B6)

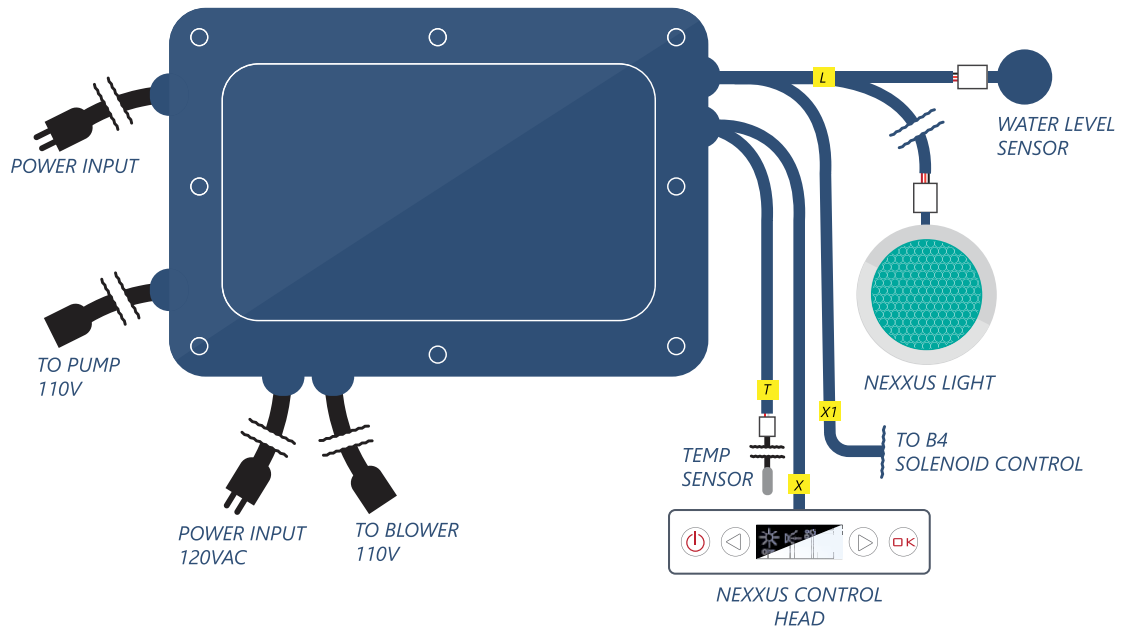

SOLENOID CONTROL SYSTEM (B4)

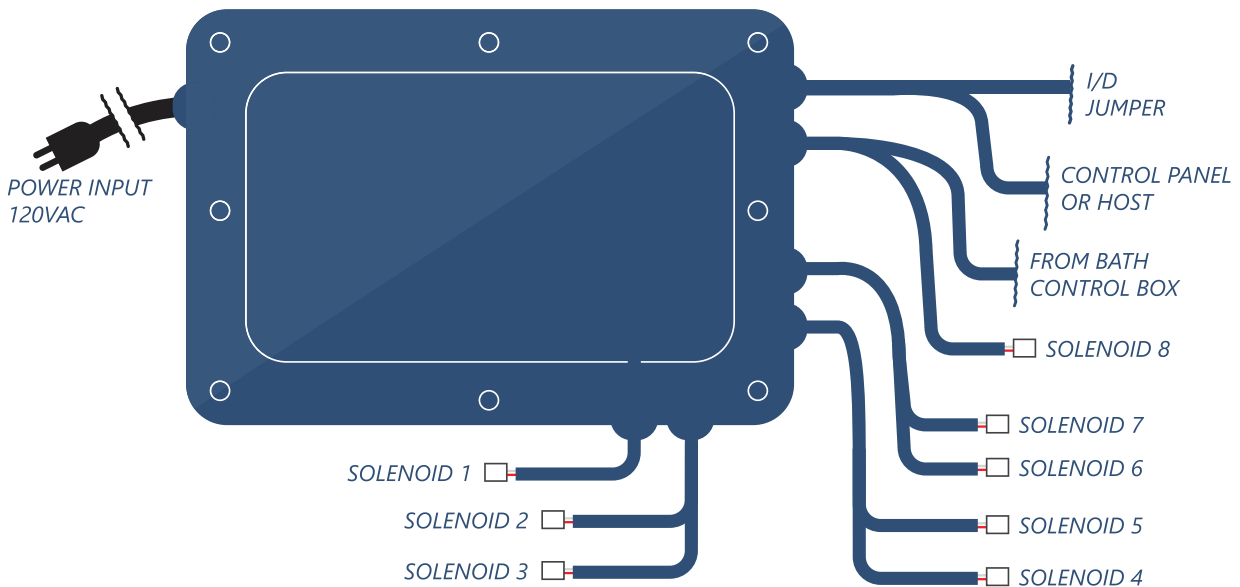

**All options shown. Available features vary between control box model.*

NEXXUS™ BATH CONTROLLER BOXES

DIGITAL CONTROLLERS

PRODUCT FEATURES

- Three Configuration Options
- Control Pump, Blower, Lights
- Control Head Sold Separately
- Links with Solenoid Controller

SPECIFICATIONS

DIMENSIONS	5-1/2" × 7-3/8" × 2-1/2"
FUNCTIONS	SINGLE SPEED PUMP OPERATION VARIABLE SPEED BLOWER OPERATION LIGHT OPERATION AUTOMATIC TIMER PURGE CYCLE B4 CONTROLLER OPERATION
TEMP SENSOR	OPTIONAL
WATER SENSOR	2-WIRE OR 3-WIRE

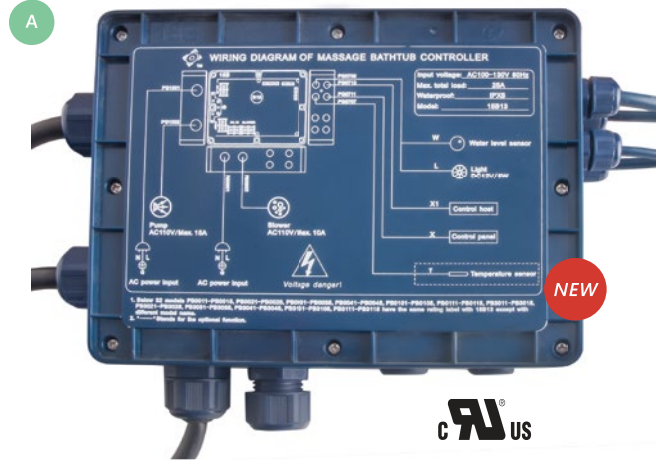

SOLENOID VALVE CONTROLLER

PRODUCT FEATURES

- Create Massage Therapy Experiences
- Alternating Jet Patterns & Speeds
- Solenoids Sold Separately
- Eight Solenoid Outputs
- Bath Controller Required

SPECIFICATIONS

DIMENSIONS	6-7/8" × 9-3/8" × 2-1/2"
ELECTRICAL	
INPUT VOLTAGE	120VAC @ 60HZ
MAX LOAD	1A MAX
SOLENOID OUTPUT	24VAC/10W

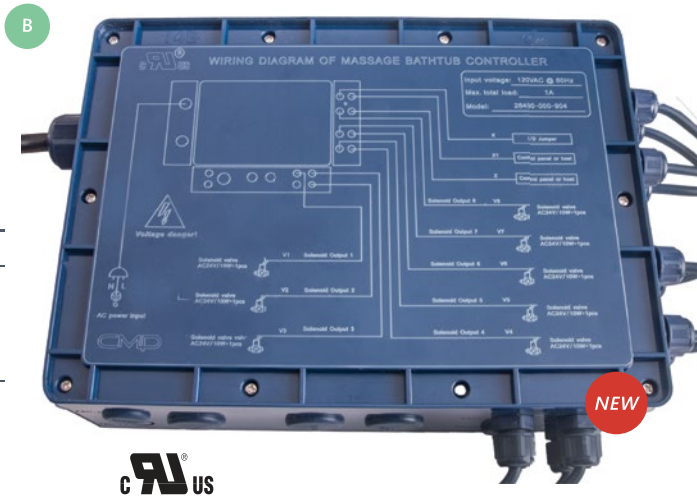

ORDERING GUIDE

REF	CMP P/N	DESCRIPTION	PUMP	BLOWER	LIGHT	SOLENOID VALVE
NEXXUS BATH CONTROL BOXES						
A	26400-000-901	B1 BATH CONTROLLER	✓	—	✓	—
A	26400-000-902	B2 BATH CONTROLLER	✓	✓	✓	—
A	26400-000-906	B6 BATH CONTROLLER	—	✓	✓	—
B	26400-000-904	B4 SOLENOID VALVE CONTROLLER	—	—	—	✓

NEXXUS™ LCD: FOUR BUTTON

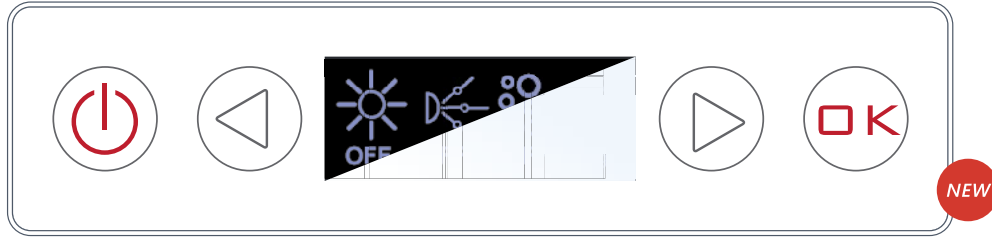

PRODUCT FEATURES

- Capacitive Touch Keys
- Back-lit Screen & Key
- White or Chrome Bezel Trim
- LCD Screen Operation
- 27 Pre-Programmed Configurations
- Multiple Seat Control
- Solenoid Valve Compatible
- Wave and Pulse Blower Operation

SPECIFICATIONS

FUNCTIONS	
PUMP OPERATION	BLOWER OPERATION
LIGHT OPERATION	SOLENOID OPERATION
AUTOMATIC TIMER	PURGE CYCLE
TEMP SENSOR	
OPTIONAL	
WATER SENSOR	
2-WIRE OR 3-WIRE	

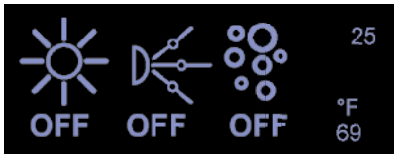

MAIN SCREEN

Displays active and available functions, countdown timer and water temperature.



LED LIGHT

Turns LED light on/off. Control the LED color. Select from seven LED colors or a slow fade color show.



PUMP/JET

Turns bath pump on/off. Control individual seats and jet groups with pre-programmed massage sequences.



BLOWER

Turns blower of/off. Choose fixed speed, wave or pulse massage. Select from six different blower massage speeds.

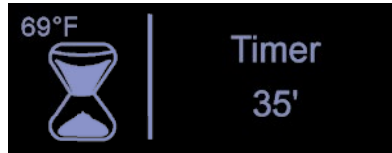

TIMER

Set a timer to automatically power down all functions..Set timers in preset increments between 5 and 60 minutes.



PROGRAMMING

Select from 27 pre-set programs and set available features. Each control head is individually programmable.

ORDERING GUIDE

CMP P/N	DESCRIPTION	BEZEL
NEXXUS LCD SERIES: FOUR BUTTON		
26413-100-110	FOUR BUTTON LCD CONTROL HEAD	WHITE
26413-102-100	FOUR BUTTON LCD CONTROL HEAD	CHROME

NEXXUS™ LCD: ROUND TWO BUTTON

PRODUCT FEATURES

- Capacitive Touch Keys
- Back-lit Screen & Keys
- White or Chrome Bezel Trim
- LCD Screen Operation
- 14 Pre-Programmed Configurations
- Multiple Seat Control
- Solenoid Valve Compatible
- Wave and Pulse Blower Operation

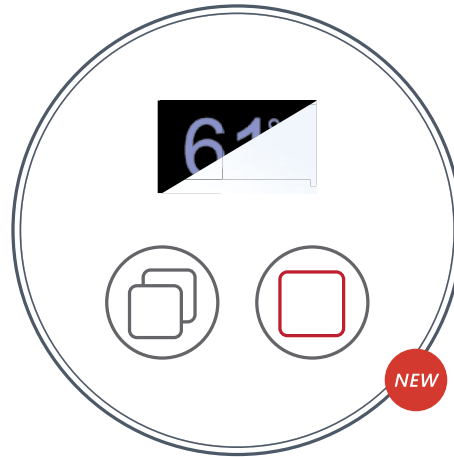

SPECIFICATIONS

FUNCTIONS	PUMP OPERATION BLOWER OPERATION LIGHT OPERATION SOLENOID OPERATION AUTOMATIC TIMER PURGE CYCLE
TEMP SENSOR	OPTIONAL
WATER SENSOR	2-WIRE OR 3-WIRE

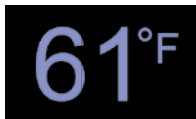

MAIN SCREEN

Displays will cycle between displaying water level and temperature.



LIGHT

Turns LED light on/off. Screen displays number of active color setting.



PUMP

Turns bath pump on/off. Display shows selection if pump is activated.



BLOWER

Cycle through six blower speed settings.



WAVE/PULSE

Select wave or pulse mode for blower settings.



TIMER

Set a timer to automatically power down all functions. Set timers in preset increments between 5 and 60 minutes.

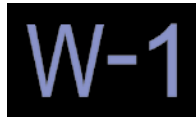

JETS

Activate programmed jets using solenoid functions. Cycle between four different jet patterns.



PROGRAMMING

Select from 14 pre-set programs and set available features. Each control head is individually programmable.

ORDERING GUIDE

CMP P/N	DESCRIPTION	BEZEL
NEXXUS LCD SERIES: FOUR BUTTON		
26410-000-110	TWO BUTTON ROUND LCD CONTROL HEAD	WHITE
26410-002-100	TWO BUTTON ROUND LCD CONTROL HEAD	CHROME

PRODUCT FEATURES

- Capacitive Touch Keys
- Back-lit Keys
- White or Chrome Bezel Trim



POWER

Turn Control On/Off



PUMP

Turn Pump On/Off



BLOWER

Activate Blower & Cycle Speed



WAVE/PULSE

Activate Wave & Pulse Modes



MINUS

Decrease Blower Speed



PLUS

Increase Blower Speed



LIGHT

Activate Light & Cycle Colors



LOCK

Locks Control Function Keys

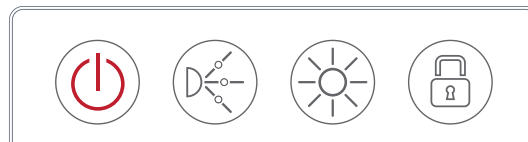
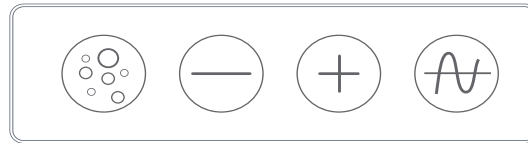
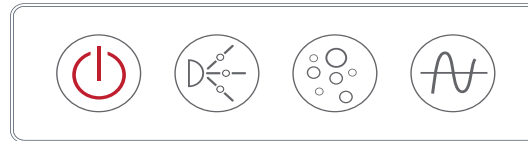
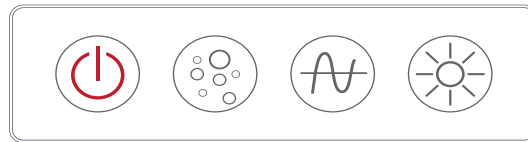
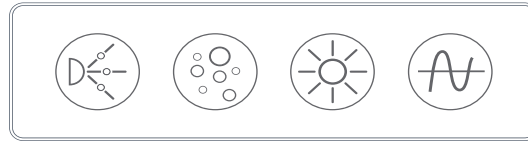
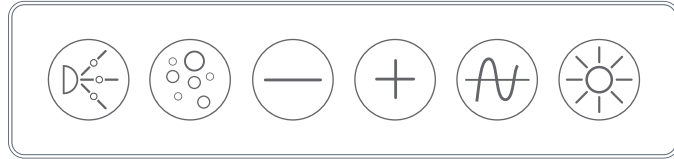

SPECIFICATIONS

AVAILABLE FUNCTIONS

PUMP OPERATION
BLOWER OPERATION
WAVE/PULSE MODES
BLOWER PLUS/MINUS
LIGHT OPERATION
CONTROL LOCK
PURGE CYCLE

WATER SENSOR

2-WIRE OR 3-WIRE

ORDERING GUIDE

WHITE BEZEL	CHROME BEZEL							DESCRIPTION
NEXXUS TOUCH SERIES								
26404-100-110	26404-102-100		✓	✓	✓	✓		SIX BUTTON CONTROL HEAD
26400-100-112	26400-102-102		✓	✓	✓		✓	FOUR BUTTON CONTROL HEAD
26400-100-114	26400-102-104	✓		✓	✓		✓	FOUR BUTTON CONTROL HEAD
26400-100-111	26400-102-101	✓	✓		✓		✓	FOUR BUTTON CONTROL HEAD
26400-100-113	26400-102-103				✓	✓	✓	FOUR BUTTON CONTROL HEAD
26400-100-110	26400-102-100	✓	✓	✓			✓	FOUR BUTTON CONTROL HEAD

NEXXUS™ TOUCH SERIES: ROUND

PRODUCT FEATURES

- Capacitive Touch Keys
- Back-lit Keys
- White or Chrome Bezel Trim



POWER
Turn On/Off



PUMP
Turn Pump On/Off



LIGHT
Activate Light & Cycle Colors

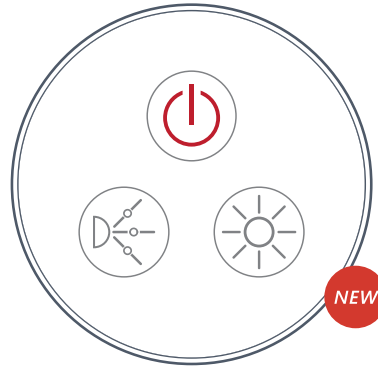

SPECIFICATIONS

AVAILABLE FUNCTIONS	PUMP OPERATION LIGHT OPERATION
WATER SENSOR	2-WIRE OR 3-WIRE

ORDERING GUIDE

WHITE BEZEL	CHROME BEZEL				DESCRIPTION
NEXXUS TOUCH SERIES: ROUND					
—	26406-002-101	✓			SINGLE BUTTON ROUND CONTROL HEAD
26406-000-103	26406-002-103	✓	✓	✓	THREE BUTTON ROUND CONTROL HEAD



Nexus

NEXXUS™ LED LIGHT

NEW

PRODUCT FEATURES

- Clean, Modern Design
- Seven LED Colors & One Light Show
- Bright, Efficient LED Light
- White or Chrome Trim Ring
- Prismatic Lens Texture
- Power Cycle Color Change

SPECIFICATIONS

LIGHT COLORS	WHITE
	LIGHT BLUE
	YELLOW
	GREEN
	PURPLE
	DARK BLUE
	RED
3- SECOND COLOR CYCLE	
VOLTAGE	12 VOLT DC
TRIM COLOR	CHROME OR WHITE



A



B



C



ORDERING GUIDE

REF	CMP P/N	DESCRIPTION	VOLTAGE
NEXXUS LED LIGHT			
A	26400-002-000	NEXXUS LED LIGHT, CHROME TRIM	12VDC
A	26400-000-000	NEXXUS LED LIGHT, WHITE TRIM	12VDC
B	26400-900-301	3-WIRE EXTENSION CORD	12V
B	26400-900-310	10 FOOT 3-WIRE EXTENSION CORD	12V
C	26400-900-304	FOUR LED LIGHT THREE WIRE EXTENSION CORD	12V

SOLENOIDS & ACCESSORIES



SENSORS & ACCESSORIES



ORDERING GUIDE

REF	CMP P/N	DESCRIPTION	VOLTAGE
NEXXUS CONTROL ACCESSORIES			
A	26400-180-310	3/4IN × 3-3/8IN (180DEG) SOLENOID	12V
B	26400-180-210	3/4IN × 2-3/8IN (180DEG) SOLENOID	24V
C	26400-180-110	3/4IN × 1-3/8IN (180DEG) SOLENOID	24V
D	26400-900-006	SOLENOID JUMPER CABLE, FEMALE SPADE CONNECTORS	--
E	26400-901-202	SOLENOID EXTENSION CORD, TWO WIRE, FEMALE SPADE CONNECTORS	--
F	26400-900-000	TEMPERATURE SENSOR PROBE	--
G	26400-900-002	CAPACITIVE WATER LEVEL SENSOR	--
H	26400-900-301	3-WIRE EXTENSION CORD	--
I	26400-900-003	CONDUCTIVE WATER LEVEL SENSOR PROBE (BOLTS, NUTS, WASHERS)	--
J	26400-900-201	CONDUCTIVE WATER LEVEL SENSOR 2-WIRE CORD	--

NEXXUS™ CONTROL ACCESSORIES

NEW

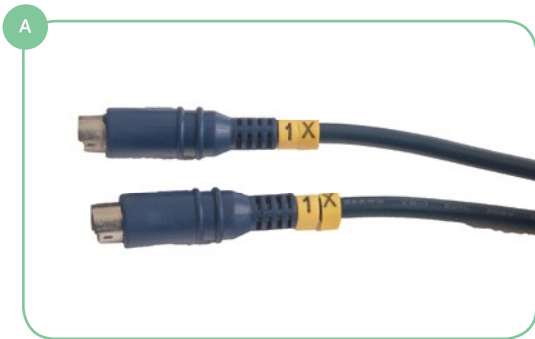

ORDERING GUIDE

REF	CMP P/N	DESCRIPTION
NEXXUS CONTROL ACCESSORIES		
A	26400-900-001	DATA EXPANSION X-CORD (MALE / MALE)
A	26400-900-010	10 FOOT X-CORD EXTENSION
B	26400-900-007	X CORD ADAPTER (FEMALE / FEMALE)
C	26400-900-900	STAINLESS STEEL CONTROL BOX BRACKET
—	26400-900-909	STAINLESS STEEL SCREW FOR CONTROL BOX BRACKET



Nexxus

NEXXUS™ AIR BUTTON LIGHTING CONTROL

PRODUCT FEATURES

- Air Button Control Box
- LED Light Connection
- Simplified Bath Control
- Not Compatible with Digital Control Pads
- Air Buttons Sold Separately

SPECIFICATIONS

AVAILABLE FUNCTIONS	AIR BUTTON LED LIGHT
INPUT VOLTAGE	120V AC
WATER SENSOR	N/A

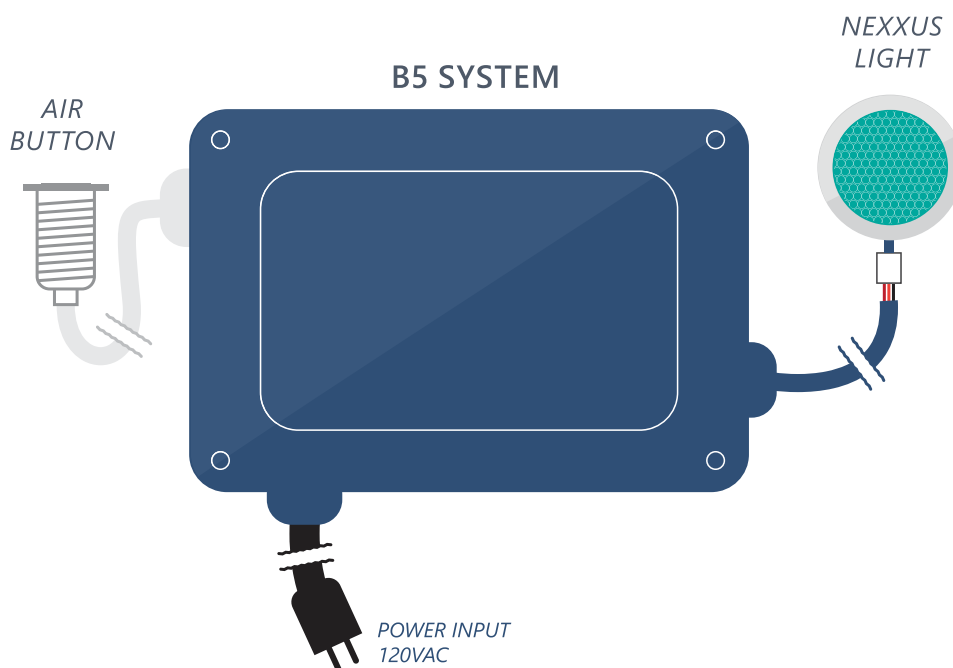
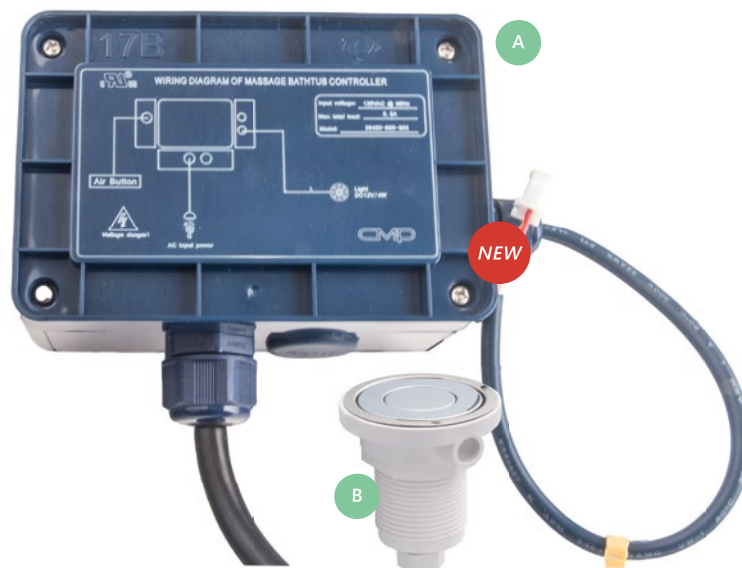

ORDERING GUIDE

REF	CMP P/N	DESCRIPTION
NEXXUS AIR BUTTON LIGHTING CONTROL		
A	26400-000-905	B5 NEXXUS AIR BUTTON CONTROL
B	—	AIR BUTTONS LISTED ON PAGE 62-63

NEXXUS™ II BATH PUMPS

Nexxus II

The Nexxus II Bath pump is compact, yet powerful. This quiet and efficient pump is available in two plumbing configurations.

PRODUCT FEATURES

- Locking Nut for Air Button Tubing
- Integrated Air Switch
- Thermal Protected Motor
- NEMA Plugs



110 Volt Single Speed
UL & CSA Approval

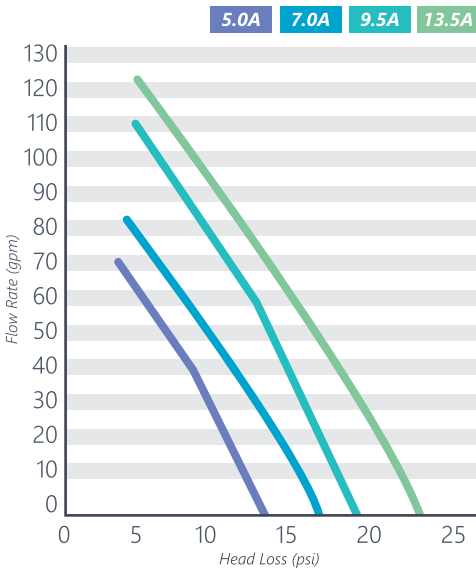

ORDERING GUIDE

REF	CMP P/N	DESCRIPTION	MAX FLOW	BOX QTY
NEXXUS II BATH PUMP				
A	27213-050-000	NEXXUS II 5.0 AMP, TOP DISCHARGE	62.5 GPM	18/72
A	27213-070-000	NEXXUS II 7.0 AMP, TOP DISCHARGE	79.5 GPM	18/72
A	27213-090-000	NEXXUS II 9.0 AMP, TOP DISCHARGE	101.7 GPM	12/48
A	27213-130-000	NEXXUS II 13.0 AMP, TOP DISCHARGE	115 GPM	12/48
B	27216-050-000	NEXXUS II 5.0 AMP, FRONT DISCHARGE*	62 GPM	18/72
B	27216-070-000	NEXXUS II 7.0 AMP, FRONT DISCHARGE*	78 GPM	18/72
B	27217-090-000	NEXXUS II 9.5 AMP, FRONT DISCHARGE*	103 GPM	12/48
B	27217-130-000	NEXXUS II 13.5 AMP, FRONT DISCHARGE*	114 GPM	12/48
C	42009-200-000	MOLDED PUMP STAND ASSEMBLY	—	1
D	27265-204-000	PLASTIC PUMP STAND	—	30
E	21014-000-000	1" x 1" x 1-1/2" SPIGOT PUMP TEE	—	180
F	21021-000-000	1-1/2" PUMP UNION	—	200

*SPECIAL ORDER ITEM, CALL FOR AVAILABILITY

NEXXUS™ | BATH PUMP

Nexxus II

The Nexxus Bath pump is a space-saving, quiet, and energy efficient pump that will perfectly meet the needs of many whirlpool bath designs.

PRODUCT FEATURES

- Locking Nut for Air Button Tubing
- Integrated Air Switch
- Thermal Protected Motor
- NEMA Plugs
- IPX5 Enclosure meets European Standards



110 Volt Single Speed
UL Approval

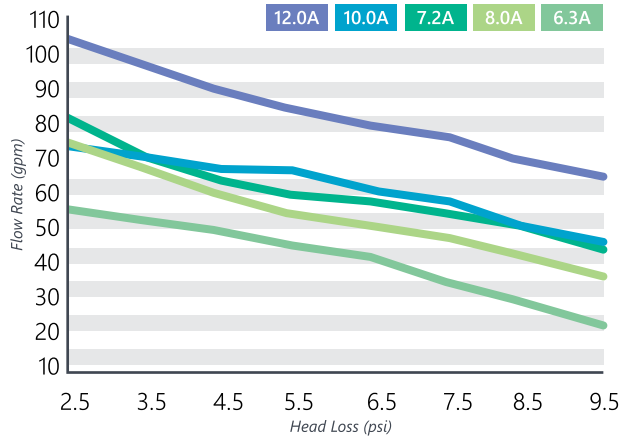

ORDERING GUIDE

REF	CMP P/N	DESCRIPTION	MAX FLOW	BOX QTY
NEXXUS BATH PUMP				
A	27210-060-000	NEXXUS 6.3 AMP	68.8 GPM	18/90
A	27210-080-000	NEXXUS 7. AMP	71.4 GPM	18/105
A	27210-090-000	NEXXUS 8.0 AMP	75.4 GPM	18/105
A	27210-110-000	NEXXUS 10.0 AMP	81.0 GPM	18/105
A	27210-130-000	NEXXUS 12.0 AMP	91.6 GPM	18/105
B	42009-200-000	MOLDED PUMP STAND ASSEMBLY	—	1
C	27265-204-000	PLASTIC PUMP STAND	—	180
D	27210-000-100	PUMP PADS (TWO REQUIRED PER PUMP)	—	180
E	21021-000-000	1-1/2" PUMP UNION	—	180
E	27239-000-900	50MM PUMP UNION	—	180

NEXXUS™ II-i BATH PUMP (WITH UNIONS)

Nexxus II-i

The Nexxus II-i with union connections is a bath pump with a variety of connection options, designed to meet international requirements.

PRODUCT FEATURES

- Locking Nut for Air Button Tubing
- Integrated Air Switch
- Thermal Protected Motor
- Includes a One Meter Cord
- IPX5 Enclosure meets European Standards



220 Volt Single Speed
CE & TUV Approval

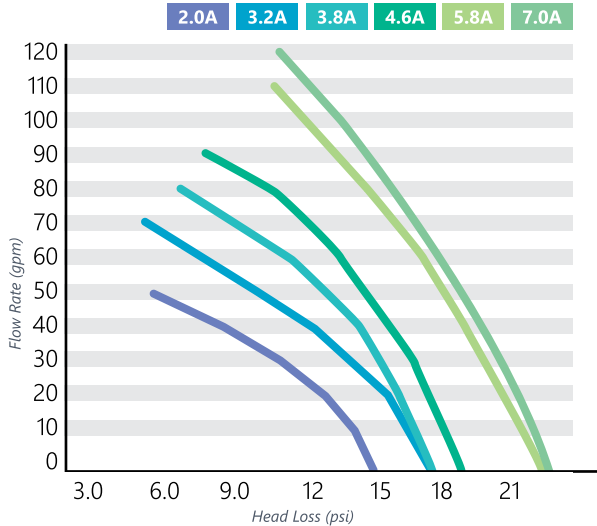

ORDERING GUIDE

REF	CMP P/N	DESCRIPTION	MAX FLOW	BOX QTY
NEXXUS II-i BATH PUMP WITH UNION CONNECTIONS				
A	27239-020-000	NEXXUS II-i 2.0 AMP	45 GPM	72
A	27239-032-000	NEXXUS II-i 3.2 AMP	65 GPM	72
A	27239-038-000	NEXXUS II-i 3.8 AMP	80 GPM	48
A	27239-046-000	NEXXUS II-i 4.6 AMP	93 GPM	48
A	27239-058-000	NEXXUS II-i 5.8 AMP	108 GPM	48
A	27239-070-000	NEXXUS II-i 7.0 AMP	118 GPM	48
B	42009-200-000	MOLDED PUMP STAND ASSEMBLY	—	1
C	27210-000-100	PUMP PADS (TWO REQUIRED PER PUMP)	—	180
D	27265-204-000	PLASTIC PUMP STAND	—	30
E	21014-000-000	1" x 1" x 1-1/2" SPIGOT PUMP TEE	—	200
F	21021-000-000	1-1/2" PUMP UNION	—	180
F	27239-000-900	50MM PUMP UNION	—	180

NEXXUS™ II-i BATH PUMP (WITH TEE)

Nexus II-i

The Nexus II-i Bath pump with Tee Outlet is a compact, quiet, and energy efficient pump designed specifically for international bath design.

PRODUCT FEATURES

- Molded Tee Outlet with 26mm Connection
- Locking Nut for Air Button Tubing
- Two Pump Pads Included with Each Pump
- Optional Air Switch
- Thermal Protected Motor
- Includes a One Meter Cord
- IPX5 Enclosure meets European Standards



220 Volt, 50Hz Single Speed
CE & TUV Approval

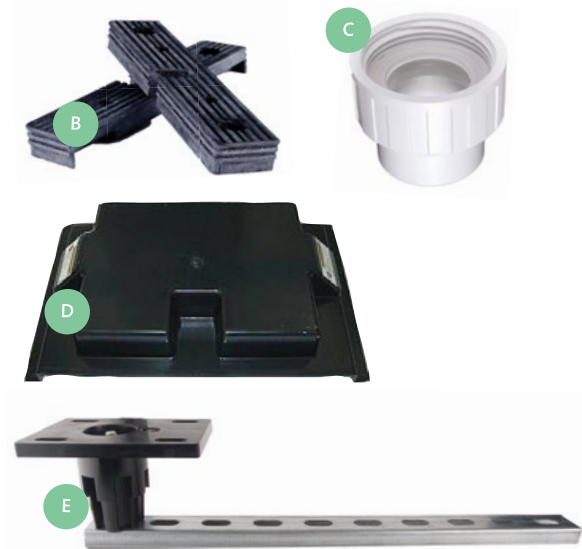
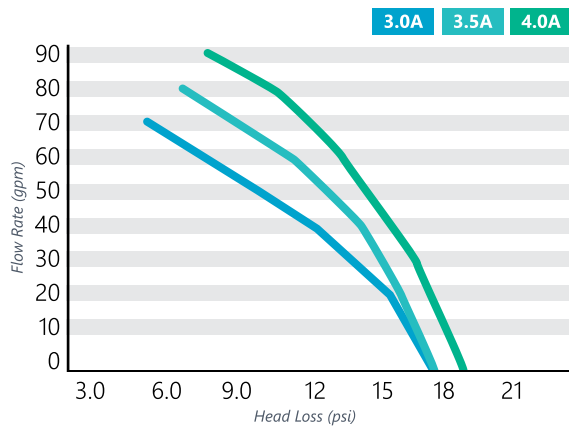

ORDERING GUIDE

REF	CMP P/N	DESCRIPTION	MAX FLOW	BOX QTY
NEXXUS II-i BATH PUMP WITH TEE DISCHARGE				
A	27239-075-000	NEXXUS II-i 3.0A, 3/4HP	60 GPM	72
A	27239-100-000	NEXXUS II-i 3.5A, 1HP	75 GPM	72
A	27239-120-000	NEXXUS II-i 4.0, 3/4HP	85 GPM	48
A	27239-075-100	NEXXUS II-i 3.0A, 3/4HP (WITH AIR SWITCH)	60 GPM	72
A	27239-100-100	NEXXUS II-i 3.5A, 1HP (WITH AIR SWITCH)	75 GPM	72
A	27239-120-100	NEXXUS II-i 4.0A, 3/4HP (WITH AIR SWITCH)	85 GPM	48
B	27210-000-100	PUMP PADS (TWO REQUIRED PER PUMP)	—	180
C	21021-000-000	1-1/2" PUMP UNION	—	180
C	21039-000-900	50MM PUMP UNION	—	180
D	27265-204-000	PLASTIC PUMP STAND	—	30
E	42009-200-000	MOLDED PUMP STAND ASSEMBLY	—	1

NEXXUS™ DH BATH HEATERS

Nexxus DH

"DURA-HEAT" ELECTRIC HEATERS

Enhance your bathing experience. The Nexxus DH electric heater helps to eliminate rapid cooling of the water temperature.

PRODUCT FEATURES

- Space Saving Compact Design
- High Limit Temp Protection
- Pressure Switch Activated
- Stainless Steel Housing
- Tee & Inline Styles



Tee: 1" Outlets, 1-1/2" Inlet
 Inline: 1-1/2 Inlet/Outlet
 UL Approval



FRICTION DISCHARGE HEATERS

An alternative to expensive electric heaters. The baffled design maximizes and creates friction heat without decreasing performance, and helps maintain water temperature.

PRODUCT FEATURES

- Safe – No Electrical Requirements
- Installs on Top of Pump Discharge Tee
- Standard Union Size for 1" Socket Outlet Connections



ORDERING GUIDE

REF	CMP P/N	DESCRIPTION	BOX QTY
NEXXUS DH HEATERS			
A	27269-150-000	120 VOLT ELECTRIC TEE HEATER, 1.5 KW	12
A	27268-320-000	220 VOLT ELECTRIC INLINE HEATER, 1.5 KW*	12
B	27268-150-000	120 VOLT ELECTRIC INLINE PRESSURE HEATER, 1.5 KW	—
B	27268-650-000	120 VOLT ELECTRIC INLINE PRESSURE HEATER, 650W	—
C	27269-009-100	FRICTION DISCHARGE MAINTENANCE HEATER	30
—	27269-009-030	OPTIONAL HEATER REDUCER (TWO REQUIRED PER HEATER)	400
—	27269-009-000	FRICTION DISCHARGE MAINTENANCE HEATER KIT	—

*SPECIAL ORDER ITEM, CALL FOR AVAILABILITY

NEXXUS™ AIR BLOWERS

Nexxus AIR

Nexxus Air blowers are compact, quiet and efficient blowers for bath. Available for U.S and International Bath requirements.

DOMESTIC (U.S) FEATURES

- Locking Nut for Air Button Tubing
- 180 Watt Heater Power
- Single Impeller Blower for US
- Integrated Air Switch for Single Speed Operation
- Variable Speed with Nexxus Bath Controls
- NEMA Cord with Plug



120 Volt, 50Hz
UL Approval



INTERNATIONAL FEATURES

- Locking Nut for Air Button Tubing
- 180 Watt Heater Power
- Double Impeller



220 Volt, 50Hz
CE, TUV Approval



ORDERING GUIDE

REF	CMP P/N	DESCRIPTION	BOX QTY
NEXXUS AIR BLOWERS			
A	27320-400-000	5.3 AMP, 120V, 50/60HZ, 400 WATT MOTOR, 180 WATT HEATER	EACH
A	27320-700-000	8.0 AMP, 120V, 50/60HZ, 700 WATT MOTOR, 180 WATT HEATER	EACH
A	27320-900-000	9.8 AMP, 120V, 50/60HZ, 900 WATT MOTOR, 180 WATT HEATER	EACH
B	27320-400-100	5.3 AMP, 220V, 50/60HZ, 400 WATT MOTOR, 180 WATT HEATER WITH OZONE*	EACH
B	27320-700-100	5.3 AMP, 220V, 50/60HZ, 700 WATT MOTOR, 180 WATT HEATER WITH OZONE*	EACH
C	27320-400-300	5.3 AMP, 220V, 50/60HZ, 400 WATT MOTOR, 180 WATT HEATER (NO OZONE)*	EACH
C	27320-700-300	5.3 AMP, 220V, 50/60HZ, 700 WATT MOTOR, 180 WATT HEATER (NO OZONE)*	EACH

*SPECIAL ORDER ITEM, CALL FOR AVAILABILITY

AIR INJECTORS

SINGLE HOLE AIR INJECTOR



LOW PROFILE AIR INJECTOR



MICRO AIR INJECTOR



ORDERING GUIDE

REF	CMP P/N	DESCRIPTION	BOX/BAG
AIR INJECTORS			
A	23036-000-000	3/8" ELL BARB AIR INJECTOR ASSEMBLY WITH 7/8" FACE*	500/50
B	23035-000-000	3/8" TEE BARB AIR INJECTOR ASSEMBLY WITH 7/8" FACE*	500/50
—	23038-010-000	AIR INJECTOR ELL BODY ONLY	1000/100
—	23037-010-000	AIR INJECTOR TEE BODY ONLY	600
—	23037-030-000	AIR INJECTOR GASKET ONLY	5000/250
C	23038-000-000	7/8" FACE 3/8" ELL BARB LOW PROFILE AIR INJECTOR ASSY & CHECK VALVE**	500/50
D	23037-000-000	7/8" FACE 3/8" TEE BARB LOW PROFILE AIR INJECTOR ASSY & CHECK VALVE **	500/50
E	23039-010-000	MICRO AIR INJECTOR ASSEMBLY, BRIGHT WHITE	500/50
E	23039-020-000	MICRO AIR INJECTOR ASSEMBLY, MEDIUM WHITE	500/50
E	23039-002-000	MICRO AIR INJECTOR ASSEMBLY, CHROME	500/50
E	23039-025-000	MICRO AIR INJECTOR ASSEMBLY, BISCUIT	500/50
—	23039-000-010	MICRO AIR INJECTOR BODY	1000/100
—	25522-256-266	MICRO AIR INJECTOR GASKET	5000/250

*NON-STOCK SPECIAL ORDER ONLY ITEM

CONTROL VALVES & BUTTONS

AIR CONTROLS & BUTTONS 62

TOP MOUNT VALVES 66

SIDE MOUNT VALVES 67

SÖL FLUSH AIR CONTROLS

SÖL Flush Air Controls are a part of the SÖL bath series featuring clean, European-influenced designs including controls, jets, suction and lighting. See the complete series on page 10.

SÖL FLUSH AIR BUTTON

PRODUCT FEATURES

- Beautiful Flush Installation
- European Inspired Modern Design
- Locking Nut for Air Button Tubing



2-11/64"/55.1mm Cap Size
1-27/32"/46.8mm Hole Size



SÖL
BATH COLLECTION

SÖL FINGERTIP AIR CONTROL

PRODUCT FEATURES

- Perfectly Flush Installation
- No Protruding Handles or Surfaces
- Fingertip Control
- Under Skirt Air Draw



2-11/64"/55.1mm Cap Size
1-27/32"/46.8mm Hole Size



SÖL
BATH COLLECTION

ORDERING GUIDE

REF	CMP P/N	DESCRIPTION	BOX/BAG
SÖL AIR BUTTON			
A	25083-800-000	FLUSH AIR BUTTON ASSEMBLY, WHITE	600/50
A	25083-802-000	FLUSH AIR BUTTON ASSEMBLY, CHROME	600/50
SÖL FINGERTIP AIR CONTROL			
B	25014-800-000	FLUSH AIR CONTROL ASSEMBLY, WHITE	400/20
B	25014-802-000	FLUSH AIR CONTROL ASSEMBLY, CHROME	400/20

AIR BUTTONS

LOW PROFILE AIR BUTTON

PRODUCT FEATURES

- Space Saving Compact Design
- Low Profile Installation
- Choice of Popular Cap Finishes



SLIM AIR BUTTON

PRODUCT FEATURES

- Locking Nut for Tubing
- CSA Approval
- Raised or Flush Button
- Choice of Popular Cap Finishes

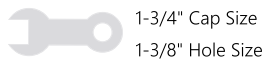

ORDERING GUIDE

REF	CMP P/N	DESCRIPTION	BOX/BAG
LOW PROFILE AIR BUTTON			
A	25025-000-000	WHITE LOW PROFILE AIR BUTTON ASSEMBLY (PICTURED)	500/50
A	25025-002-000	POLISHED CHROME LOW PROFILE AIR BUTTON ASSEMBLY	500/50
A	25025-003-000	POLISHED BRASS LOW PROFILE AIR BUTTON ASSEMBLY	500/50
—	26204-653-820	GASKET FOR LOW PROFILE AIR BUTTON	—
B	25025-000-040	LOW PROFILE CAP & BUTTON	500/50
C	25025-000-110	LOW PROFILE BODY ASSEMBLY (BODY, NUT, BELLOWS)	500/50
SLIM AIR BUTTON			
D	25083-000-000	WHITE SLIM AIR BUTTON ASSEMBLY	600/50
D	25083-002-000	POLISHED CHROME AIR BUTTON ASSEMBLY (PICTURED)	600/50
D	25083-003-000	POLISHED BRASS AIR BUTTON ASSEMBLY	600/50
—	25083-300-000	SLIM AIR BUTTON ASSEMBLY W/ ELL BODY (BODY, GASKET, BELLOWS, CAP)	—
—	25083-100-000	COMPRESSION NUT FOR TUBING	5000
—	25083-000-041	PROTECTIVE CAP FOR SLIM CAP & BUTTON	1600
E	25083-000-040	SLIM CAP & BUTTON	600/50
F	25083-200-000	SLIM AIR BUTTON WITH SLIM CAP AND RAISED BUTTON ASSEMBLY	600/50
F	25083-200-040	SLIM CAP AND RAISED BUTTON	600/50
G	25083-000-110	SLIM BODY ASSEMBLY (NUT, GASKET, BELLOWS)	600/50
H	25083-300-100	SLIM L BODY NO CAP ASSEMBLY WITH 90DEG BARB (NUT, GASKET, BELLOWS)	—
I	25014-050-000	GASKET FOR SLIM AIR BUTTON	600/50
J	25040-019-050	LOOP ADAPTER (OPTIONAL)	—

AIR CONTROLS

UNDER SKIRT DRAW AIR CONTROL

PRODUCT FEATURES

- Space Saving Compact Design
- Under Skirt Draw

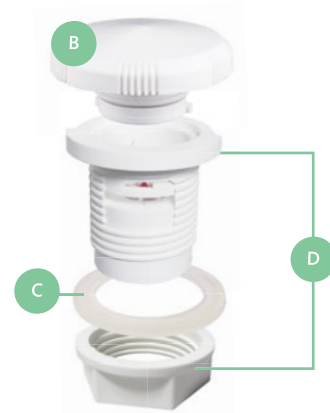
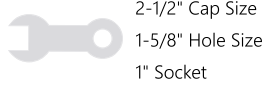

UNDER SKIRT DRAW SLIM AIR CONTROL

PRODUCT FEATURES

- White or Polished Chrome
- Side Mount Control Available
- Low Profile Control Knob

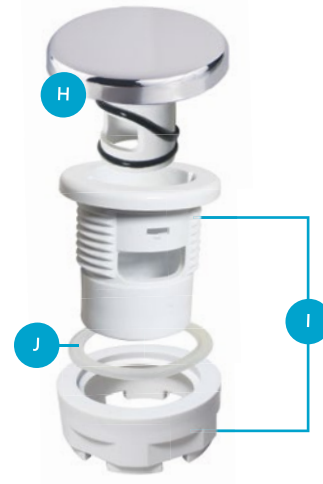
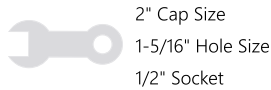

ORDERING GUIDE

REF	CMP P/N	DESCRIPTION	BOX/BAG
UNDER SKIRT DRAW AIR CONTROL			
A	25024-000-000	WHITE UNDER SKIRT AIR CONTROL ASSEMBLY (PICTURED)	250/25
A	25024-002-000*	POLISHED CHROME UNDER SKIRT AIR CONTROL ASSEMBLY	250/25
A	25024-003-000*	POLISHED BRASS UNDER SKIRT AIR CONTROL ASSEMBLY	250/25
A	25024-000-132*	STAINLESS STEEL CAP, CHROME FINISH UNDER SKIRT AIR CONTROL	250/25
A	25024-000-133*	STAINLESS STEEL CAP, BRASS FINISH UNDER SKIRT AIR CONTROL	250/25
B	25024-000-100	CAP FOR UNDER SKIRT AIR DRAW CONTROL	400/20
C	25024-000-200	BODY & NUT FOR UNDER SKIRT AIR DRAW CONTROL	400/20
D	26205-554-230	GASKET FOR UNDER SKIRT AIR DRAW CONTROL	400/20
UNDER SKIRT DRAW SLIM AIR CONTROL			
E	25015-000-000	WHITE UNDER SKIRT SLIM AIR CONTROL ASSEMBLY	400/20
E	25015-002-000	POLISHED CHROME UNDER SKIRT AIR CONTROL ASSEMBLY (PICTURED)	400/20
F	25015-100-000	SIDE MOUNT AIR CONTROL (ELBOW SOLD SEPARATELY)	400/20
G	25013-000-300	90 DEGREE ELBOW FOR SIDE MOUNT AIR CONTROL (SOLD SEPARATELY)	400/20
H	25014-000-100	CAP FOR UNDER SKIRT DRAW AIR CONTROLS	400/20
I	25015-000-200	BODY & NUT FOR UNDER SKIRT DRAW AIR CONTROL (TOP MOUNT)	400/20
J	25014-050-000	GASKET FOR UNDER SKIRT DRAW AIR CONTROL	400/20

*NON-STOCK SPECIAL ORDER ONLY ITEM

AIR CONTROLS

TOP DRAW SLIM AIR CONTROL

PRODUCT FEATURES

- White or Polished Chrome
- Slim Cap Design

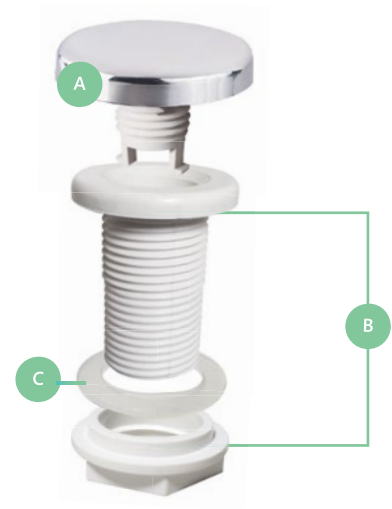
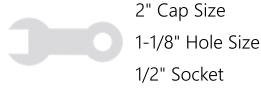

LOW PROFILE AIR CONTROL

PRODUCT FEATURES

- Low Profile Install Style
- Three Color Options

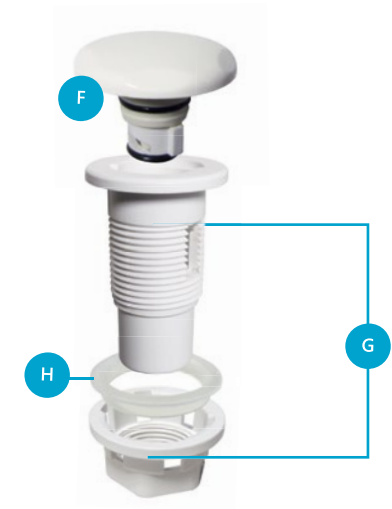

ORDERING GUIDE

REF	CMP P/N	DESCRIPTION	BOX/BAG
TOP DRAW SLIM AIR CONTROL			
A	25014-000-000	WHITE TOP DRAW AIR CONTROL ASSEMBLY	400/20
A	25014-002-000	POLISHED CHROME TOP DRAW AIR CONTROL ASSEMBLY (PICTURED)	400/20
B	25015-000-100	CAP FOR TOP DRAW AIR CONTROL	400/20
C	25014-000-200	BODY & NUT FOR TOP DRAW AIR CONTROL	400/20
D	26204-102-820	GASKET FOR TOP DRAW AIR CONTROL	400/20
LOW PROFILE AIR CONTROL			
E	25013-000-000	WHITE LOW PROFILE AIR CONTROL ASSEMBLY (PICTURED)	500
E	25013-634-500	BONE LOW PROFILE AIR CONTROL ASSEMBLY	500
E	25013-652-800	BISCUIT LOW PROFILE AIR CONTROL ASSEMBLY	500
F	25013-000-110	CAP FOR LOW PROFILE AIR CONTROL	400/20
G	25013-000-200	BODY & NUT FOR LOW PROFILE AIR CONTROL	400/20
H	25013-000-030	GASKET FOR LOW PROFILE AIR CONTROL	400/20
—	25013-000-100	90° ELBOW FOR LOW PROFILE AIR CONTROL	2000/100

1" TOP MOUNT VALVES

PRODUCT FEATURES

- 100% Shut Off Body Available for On/Off Valve
- On/Off or 3-Way Flow Control
- Low Profile Handle
- Optional Raised Handle with Larger Surface Area for Easy Adjustment

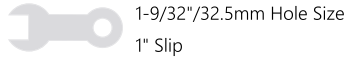

1-9/32"/32.5mm Hole Size
1" Slip



ORDERING GUIDE

REF	CMP P/N	DESCRIPTION	BOX/BAG
1" TOP MOUNT VALVES			
A	24039-100-000	1" TOP MOUNT 3-WAY DIVERTER VALVE COMPLETE ASSEMBLY (PICTURED)	50
B	24031-100-000	1" TOP MOUNT ON/OFF VALVE COMPLETE ASSEMBLY (PICTURED)	50
C	24039-100-010	SMOOTH CAP	600/50
D	24039-200-020	RAISED HANDLE CAP	600/50
E	24039-000-030	WALL FITTING FOR 1" TOP MOUNT VALVES	1200
F	24039-000-060	GASKET FOR TOP MOUNT VALVE	2000/100
G	24031-000-100	STANDARD BODY ONLY FOR 1" TOP MOUNT ON/OFF VALVE	150
G	24031-800-100	100% SHUT OFF BODY ASSY FOR 1" TM ON/OFF VALVE (W/ GASKET & WALL FITTING)	150
H	24039-000-100	1" 3-WAY BODY ONLY FOR 1" TOP MOUNT 3-WAY DIVERTER VALVE	150

1" SIDE MOUNT VALVES

PRODUCT FEATURES

- On/Off or 3-Way Flow Control
- Low Profile Handle
- Optional Raised Handle with Larger Surface Area for Easy Adjustment



1-7/32"/30.9mm Hole Size
1" Slip

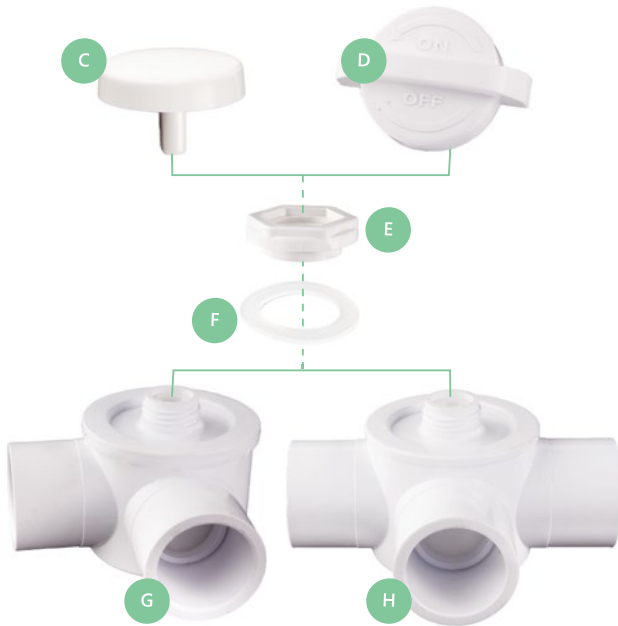

ORDERING GUIDE

REF	CMP P/N	DESCRIPTION	BOX/BAG
1" SIDE MOUNT VALVES			
A	24032-100-000	1" SIDE MOUNT ON/OFF VALVE COMPLETE ASSEMBLY (PICTURED)	50
B	24038-100-000	1" SIDE MOUNT 3-WAY DIVERTER COMPLETE ASSEMBLY (PICTURED)	50
C	24039-100-010	SMOOTH CAP	600/50
D	24039-200-020	RAISED HANDLE CAP	600/50
E	24032-000-020	WALL FITTING FOR 1" SIDE MOUNT VALVES	1200
F	24039-000-060	GASKET	2000/100
G	24032-000-100	BODY ONLY FOR 1" SIDE MOUNT ON/OFF VALVE	150
E,F,G	24032-900-000	BODY ASSY FOR 1" SIDE MOUNT ON/OFF VALVE (W/ GASKET & WALL FITTING)	150
H	24038-000-100	BODY ONLY FOR 1" SIDE MOUNT 3-WAY DIVERTER VALVE	150

*FORWARD-THINKING
DESIGNS . . .
INNOVATIVE BATH
PRODUCTS*

CMP BATH
PRODUCTS

WHITE GOODS

SUCTIONS 70

FITTINGS 74

UNIONS & CHECK VALVES 75

BATH MANIFOLDS 76

FLEX HOSE & TUBING 77

SÖL™ SAFETY SUCTION

PRODUCT FEATURES

- 110GPM Rating with Vacuum Break
- 52GPM without Vacuum Break
- Silicone Injection Ports
- IAPMO Certified
- UL Recognized
- CSA Certified



3-11/32" / 92.3mm Hole Size
1-1/2" or 50mm Slip

SÖL
BATH COLLECTION

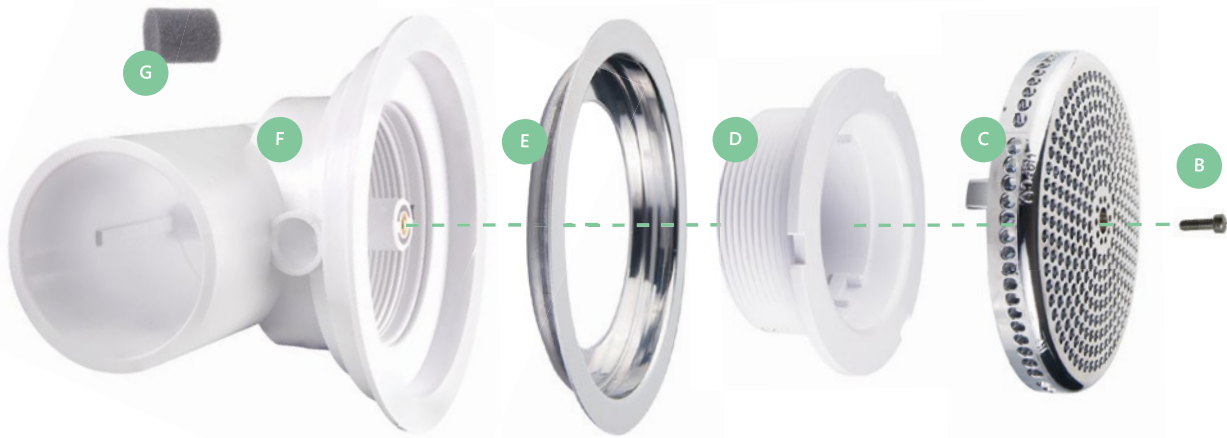

ORDERING GUIDE

REF	CMP P/N	DESCRIPTION	BOX/BAG
110GPM SOL SAFETY SUCTION			
A	25216-302-000	1.5" SLIP SÖL CLOSE-FIT FLUSH SAFETY SUCTION ASSY (PICTURED)	150
A	25216-502-000	50MM SÖL CLOSE-FIT FLUSH SAFETY SUCTION ASSY	150
B	61000-506-025	COVER SCREW	150
C	25216-000-100	SUCTION COVER	300/50
—	25216-100-100	OPTIONAL 80GPM SUCTION COVER	300/50
D	25216-200-030	CLOSE-FIT WALL FITTING	200
D	25216-000-030	110 GPM WALL FITTING	
E	25216-100-302	SS FLANGE FOR SUCTION COVER, WHITE	150
E	25216-102-302	SS FLANGE FOR SUCTION COVER, CHROME (PICTURED)	150
F	25216-250-200	1.5" SLIP CLOSE-FIT BODY WITH SPACER	100
F	25216-550-200	50MM SLIP CLOSE-FIT BODY WITH SPACER	100
F	25216-100-400	STANDARD 110 GPM SUCTION BODY WITH SPACER	
G	25202-900-000	FOAM FILTER	300
—	25216-999-999	TOOL FOR SUCTION WALL FITTING	—

150 GPM SAFETY SUCTION

PRODUCT FEATURES

- 150GMP Rating with Vacuum Break
- IAPMO Certified
- UL Recognized

 3-3/8" Hole Size
2" Slip



ORDERING GUIDE

REF	CMP P/N	DESCRIPTION	BOX QTY
150 GPM SAFETY SUCTION			
A	25202-000-000	150 GPM SAFETY SUCTION ASSEMBLY	100
B	61000-050-012	COVER SCREW	100
C	25202-000-100	SUCTION COVER	300
D	25202-000-200	2" SLIP ELBOW FITTING	60
E	25202-000-040	COMPENSATOR RING	480
F	25202-000-030	SUCTION NUT	450
—	25202-999-999	TOOL FOR SUCTION NUT	—

110 GPM LOW PROFILE SAFETY SUCTION

PRODUCT FEATURES

- 110GPM Rating with Vacuum Break
- 52GPM without Vacuum Break
- Silicone Injection Ports
- IAPMO Certified
- UL Recognized
- CSA Certified

 2-5/8" Hole Size
1.5" Slip or 50mm

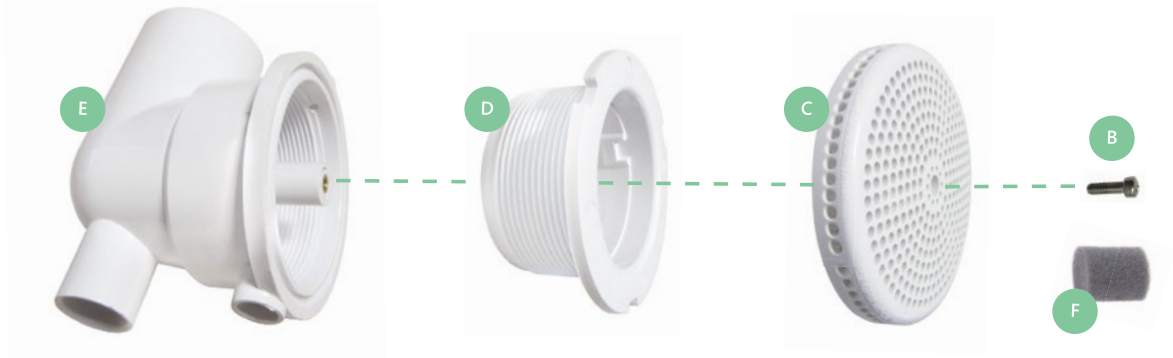

ORDERING GUIDE

REF	CMP P/N	DESCRIPTION	BOX/BAG
110 GPM LOW PROFILE SAFETY SUCTION			
A	25216-000-000	110 GPM LOW PROFILE SAFETY SUCTION ASSEMBLY	150
B	61000-506-025	COVER SCREW	150
C	25216-000-100	SUCTION COVER	300/50
—	25216-100-100	OPTIONAL 80 GPM SUCTION COVER	300/50
D	25216-000-030	WALL FITTING	100
D	25216-200-030	CLOSE FIT WALL FITTING FOR CLOSE FIT BODIES	200
E	25216-000-200	1.5" SLIP BODY	100
E	25216-200-200	1.5" SLIP CLOSE FIT BODY	100
E	25216-500-200	CLOSE FIT BODY 50MM SLIP	100
F	25202-900-000	FOAM FILTER FOR SAFETY SUCTION	300
—	25216-999-999	TOOL FOR SUCTION WALL FITTING	—

94 GPM SUCTION

PRODUCT FEATURES

- Three Variations Available
- UL Recognized

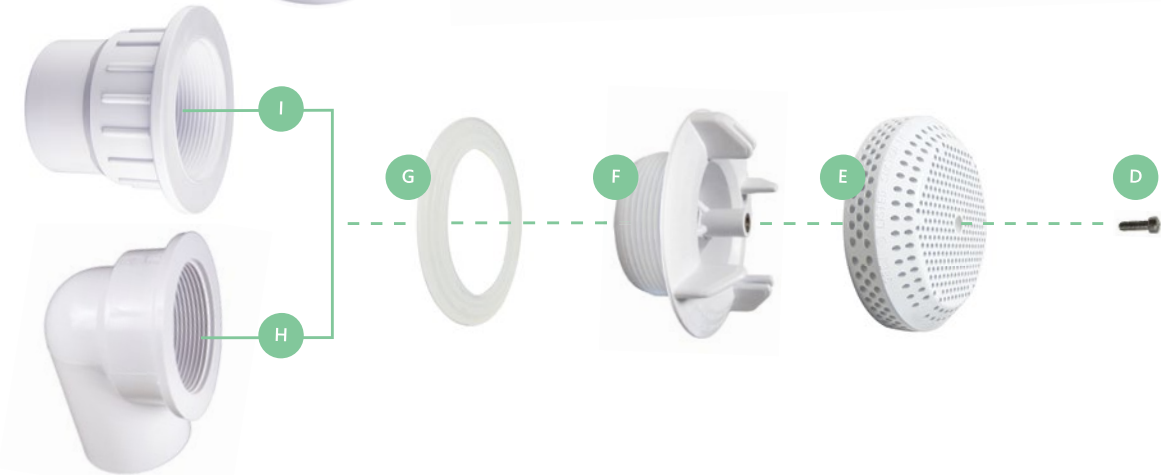
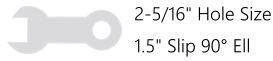

ORDERING GUIDE

REF	CMP P/N	DESCRIPTION	BOX/BAG
94 GPM SUCTION WITH ELL FITTING			
A	25206-100-000	94 GPM SUCTION WITH ELL FITTING ASSEMBLY (1.5" SLIP)	100
—	25206-500-000	94 GPM SUCTION WITH EXTENDED WALL FITTING ASSEMBLY	100
B	25205-000-000	94 GPM SUCTION WITH ADAPTER ASSEMBLY (2" SPIGOT / 1.5" SLIP)	120
B	25204-001-000*	94 GPM SUCTION WITH ADAPTER ASSEMBLY (2" SLIP)	100
C	25206-000-000	94 GPM SUCTION ASSEMBLY (1-1/2" STRAIGHT SLIP)	150
D	61000-050-012	COVER SCREW	150
E	25026-000-030	SUCTION COVER	200
E	25206-000-032	STAINLESS STEEL/CHROME FINISH SUCTION COVER	150
E	25206-000-033	STAINLESS STEEL/BRASS FINISH SUCTION COVER	200
F	25206-100-200	WALL FITTING FOR ELL FITTING AND 2" ADAPTER	150
—	25026-010-200	EXTENDED WALL FITTING FOR ELL FITTING	100
G	26207-705-930	GASKET	1500/150
H	25205-070-000	1.5" SLIP ELBOW FITTING	150
I	25523-500-010	1.5" SLIP SPIGOT ADAPTER	150
D,F,H	25206-100-150	ELBOW, WALL FITTING, & SCREW KIT (NO COVER)	—
—	25206-000-200	1.5" STRAIGHT SLIP WALL FITTING	100

ELBOWS & FITTINGS



ORDERING GUIDE

REF	CMP P/N	DESCRIPTION	FITTING SIZE	BOX QTY
ELBOWS & FITTINGS				
A	21016-000-000	1" COUPLING	1" SOCKET×1" SOCKET	500
A	21015-000-000	1.5" COUPLING	1.5" SOCKET × 1.5" SOCKET	300
B	21018-000-000	1" 90° STREET ELL	1" SOCKET × 1.5" SPIGOT	500
B	21018-100-000	SHORT 1" 90° STREET ELL	1" SOCKET × 1.5" SPIGOT	500
B	21013-000-000	1.5" 90° STREET ELL	1.5" SOCKET × 1.5" SPIGOT	150
C	21008-050-000	1/2" 90° ELL	1/2" SOCKET X 1/2" SOCKET	
C	21008-000-000	2" 90° ELL	2" SOCKET × 2" SOCKET	100
C	21013-200-000	2" 90° STREET ELL	2" SOCKET × 2" SPIGOT	100
D	21105-000-000	1.5" SWEEP 90° ELL	1.5" SOCKET × 1.5" SOCKET	100
D	21005-000-000	2" SWEEP 90° ELL	2" SOCKET × 2" SOCKET (WIDE THROAT)	50
E	21020-000-000	1" 45° ELL	1" SOCKET × 1" SOCKET	500
F	21010-000-000	1.5" 45° STREET ELL	1.5" SOCKET × 1.5" SPIGOT	200
F	21010-200-000	2" 45° STREET ELL	2" SOCKET × 2" SPIGOT	100
G	21011-000-000	LEFT 1.5" 90° DRAIN ELL	1.5" SOCKET × 1.5" SPIGOT	150
G	21012-000-000	RIGHT 1.5" 90° DRAIN ELL	1.5" SOCKET × 1.5" SPIGOT	150
H	24200-200-000	26MM WYE	26MM	150
I	21009-000-000	1" LOW ANGLE WYE	1" SOCKET	200
J	21017-000-000	REDUCER TEE	1" SOCKET × 1" SOCKET × 3/4" SOCKET/1" SPIGOT	300
K	21014-000-000	PUMP TEE	1" SOCKET × 1" SOCKET × 1.5" SPIGOT	200
L	21019-000-000	1" 3-WAY ELL	1" SOCKET × 1" SOCKET × 1" SPIGOT	350
M	24202-126-000	26MM × 3/4" TEE	26MM × 26MM × 3/4" SPIGOT	

UNIONS & CHECK VALVES



ORDERING GUIDE

REF	CMP P/N	DESCRIPTION	BOX/BAG
UNIONS			
A	21045-004-000	1" SLIP PUMP UNION	250
B	21021-000-000	1.5" SLIP PUMP UNION (NUT, SLEEVE, T-GASKET)	180
B	27239-000-900	50MM SLIP PUMP UNION (NUT, SLEEVE, T-GASKET)	180
B	21021-008-000	1.5" SLIP PUMP UNION (NUT, THICK SLEEVE, T-GASKET)	180
B	21023-000-000	2" SLIP PUMP UNION (NUT, SLEEVE, O-RING)	108
C	21021-800-000	PUMP UNION TEE 26MM × 26MM × 1.5" SPIGOT	150
—	21021-030-000	T-GASKET	2500
D	21014-100-000	1" SLIP LOW PROFILE PUMP SWEEP TEE UNION	130
D	21021-900-000	1" SLIP STANDARD PUMP SWEEP TEE UNION	150
E	21047-000-000	1.5" SOCKET INLINE UNION (NUT, SLEEVE, T-GASKET, THREADED TAILPIECE)	100
F	21046-000-000	1.5" BUTTRESS × 1.5" SOCKET UNION TAILPIECE	200
G	25300-004-070	1.5" SPLIT UNION NUT & TWO SCREWS	400/50
CHECK VALVES			
H	25062-000-000	1" SOCKET SWING CHECK VALVE	120
I	25069-000-000	1.5" SOCKET UNIONIZED CHECK VALVE (1/4 LB SPRING)	112
I	25069-100-000	1.5" SOCKET UNIONIZED CHECK VALVE (3/32 LB SPRING)	75
J	25067-000-000	1.5" SOCKET/2" SPIGOT AIR CHECK VALVE (1/4 LB SPRING)	100
K	25070-000-100	1/2" SLIP POP CHECK VALVE	400
L	21064-000-000	3/8" RIBBED BARB CHECK VALVE	1000/100
L	21064-000-010	3/8" RIBBED BARB NEOPERL CHECK VALVE BODY ONLY	1000/100
M	25066-375-000	TUBING CHECK VALVE FOR 3/8" VINYL TUBE	1000/100
M	25066-275-000	TUBING CHECK VALVE FOR 3/8" VINYL TUBE (WITH SS. CHECK BALL)	1000/100
N	21064-500-000	1/2" SLIP CHECK VALVE	1000/100
O	25060-000-000	1" SLIP CHECK VALVE	600
P	27266-000-000	1" SLIP SUCTION SAFETY VALVE (2.5 LB STAINLESS STEEL SPRING)	240
P	27267-001-000	1" SLIP SUCTION SAFETY VALVE (6 LB STAINLESS STEEL SPRING)	240

MANIFOLDS & ADAPTERS

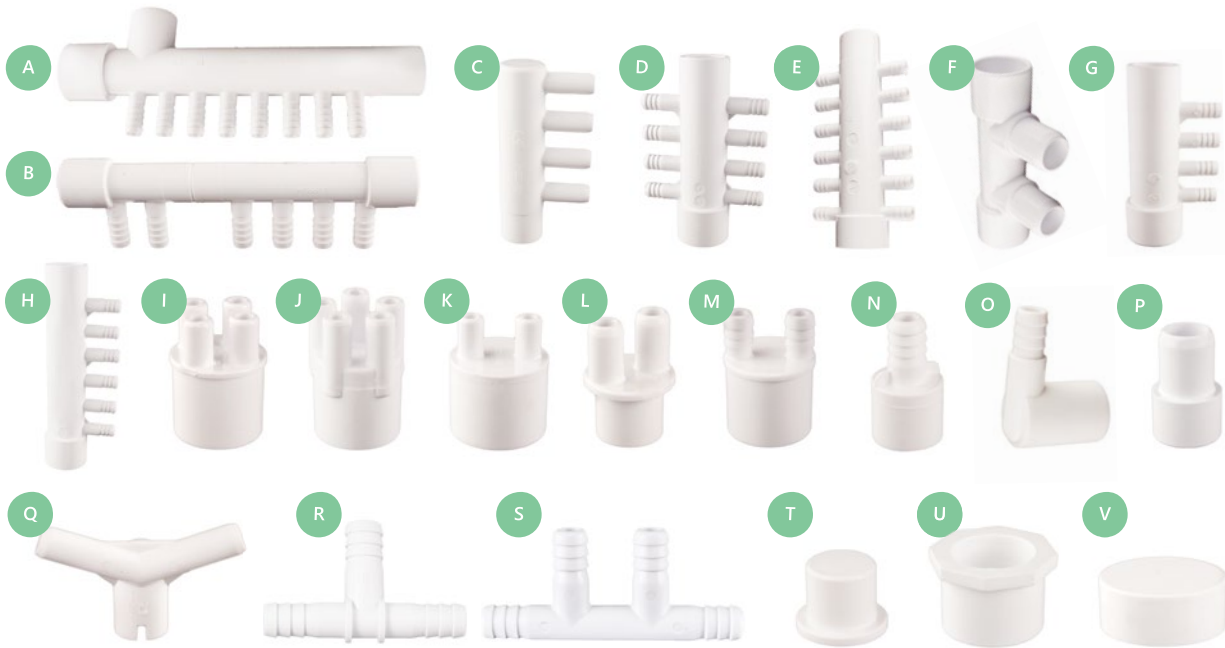

ORDERING GUIDE

REF	CMP P/N	DESCRIPTION	FITTING SIZE	BOX/BAG
MANIFOLDS & ADAPTERS				
A	21028-000-000	8 PORT 3/8" RIBBED BARB	1" SOCKET × 1" SPIGOT × 1" SPIGOT	85
B	21155-060-000	6 PORT 3/8" RIBBED BARB	1/2" SOCKET × 1/2" SOCKET	200
C	21052-100-000	4 PORT 3/8" SMOOTH BARB	1/2" SPIGOT × BLIND	500/50
D	21162-080-000	8 PORT 3/8" RIBBED BARB	1" SPIGOT × 1" SOCKET	200
E	21162-120-000	12 PORT 3/8" RIBBED BARB	1" SOCKET × 1" SOCKET	220
F	21086-000-000	2 PORT 26MM SMOOTH BARB	1" SOCKET × 1" SOCKET	100
G	21081-900-000	4 PORT 3/8" RIBBED BARB	1" SOCKET × 1" SPIGOT , TWO PLUGS & 1" CAP	250/25
G	21081-000-000	4 PORT 3/8" RIBBED BARB	1" SOCKET × 1" SPIGOT	250/25
H	21081-060-000	6 PORT 3/8" RIBBED BARB	1" SPIGOT × 1" SOCKET	200
I	21157-040-000	4 PORT 3/8" SMOOTH BARB	1" SPIGOT (PLUGS SOLD SEPARATELY)	500
I	21159-040-000	4 PORT 3/8" SMOOTH BARB	1" SLIP (TWO PLUGS)	300/20
J	21159-050-000*	5 PORT 3/8" SMOOTH BARB	1" SLIP (TWO PLUGS)	300/20
J	21080-000-000	5 PORT 3/8" SMOOTH BARB	1" SPIGOT	500/25
K	21156-020-000*	2 PORT 3/8" SMOOTH BARB	1" SLIP (TWO PLUGS)	300/20
K	21157-020-000*	2 PORT 3/8" SMOOTH BARB	1" SPIGOT (TWO PLUGS)	300/20
L	21157-520-000	2 PORT 3/8" SMOOTH BARB	1/2" SPIGOT	1200/100
M	21033-000-000	2 PORT 3/8" RIBBED BARB	1" SPIGOT	1000/50
N	21031-030-000	1/2" SPIGOT × 3/8" RIBBED BARB	1/2" SPIGOT	1000/100
O	21043-000-000	1/2" SPIGOT × 3/8" RIBBED BARB	1/2" SPIGOT	2000/100
P	24200-300-000	1" SPIGOT × 26MM SMOOTH BARB	1" SPIGOT	600
Q	21065-000-000	3/8" SMOOTH BARB WYE	USE WITH V-JET	1000/100
R	21061-050-000	3/8" RIBBED BARB TEE	3/8" × 3/8" × 3/8" RIBBED BARB	—
S	21061-300-000	3/8" 4-WAY BARB TEE	3/8" × 3/8" × 3/8" × 3/8" RIBBED BARB	—
T	21028-000-010	3/8" BARB PLUG	3/8" BARB	85
U	21131-100-010	1/2" SOCKET PLUG	1/2" SOCKET	2000/200
U	21022-000-000	1" SOCKET PLUG	1" SOCKET	500/25
U	25577-950-020	1-1/2" SOCKET PLUG	1-1/2" SOCKET	600/50
V	24200-100-000	26MM CAP	26MM	1200/100
V	21081-060-020	1" CAP	1"	1000/100

FLEX HOSE & TUBING

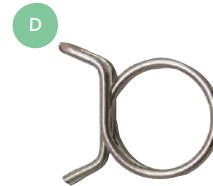

ORDERING GUIDE

REF	CMP P/N	DESCRIPTION	BOX/BAG
FLEX HOSE & TUBING			
A	22143-500-010	10FT AIR BUTTON TUBING, CLEAR VINYL (1/8" x 1/4")	EACH
A	22143-500-000	500FT AIR BUTTON TUBING, CLEAR VINYL (1/8" x 1/4")	EACH
B	22005-100-000	100FT FLEX HOSE (1/2")	EACH
B	22010-050-000	50FT FLEX HOSE (1")	EACH
B	22015-050-000	50FT FLEX HOSE (1-1/2")	EACH
B	22020-050-000	50FT FLEX HOSE (2")	EACH
C	22145-400-100	400FT WHITE VINYL TUBING (3/8" x 9/16")	EACH
C	22180-100-000	100FT WHITE VINYL TUBING (26MM)	EACH
D	24200-400-000	CLAMP FOR 26MM TUBING	1000
D	24375-000-000	CLAMP FOR 3/8" TUBING	5000/500



BATH ACCESSORIES

BATHTUB FEET *80*

SHOWER ACCESSORIES *81*

AROMA & CHROMATHERAPY *82*

ADA GRAB BARS & SHOWER SEATS *84*

SHOWER CURTAINS *85*

SOLID BRASS BATHTUB FEET

Classic, elegant style for bathroom decor; built for strength and durability.

PRODUCT FEATURES

- Solid Brass Feet
- Adjustable Leveling Foot
- Available in Five Popular Finishes

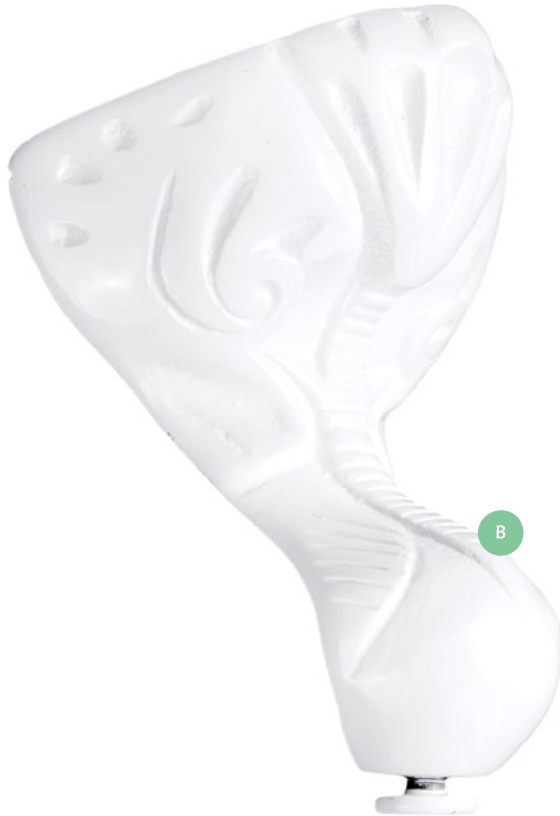

ORDERING GUIDE

REF	CMP P/N	DESCRIPTION	BOX QTY
SOLID BRASS BATHTUB FEET			
A	27264-202-000	POLISHED CHROME BATHTUB FEET	4
B	27264-210-000	POWDER COATED WHITE BATHTUB FEET	4
—	27264-203-000	POLISHED BRASS BATHTUB FEET	4
—	27264-213-000*	OIL-RUBBED BRONZE BATHTUB FEET*	4
—	27264-208-000	BRUSHED NICKEL BATHTUB FEET	4

*NON-STOCK SPECIAL ORDER ONLY ITEM

SHOWER ACCESSORIES

CAULK-FREE SHOWER DRAIN

PRODUCT FEATURES

- Brass Body with Chrome Cover
- Gasket Seal, No Caulk Required
- UPC Approved
- 2" IPS Connection



SHOWER SOAP TRAY

PRODUCT FEATURES

- Includes Clear Tray & Wall Housing
- Stainless Steel or Powder Coating Housing



ORDERING GUIDE

REF	CMP P/N	DESCRIPTION	BOX QTY
SHOWER ACCESSORIES			
A	27253-002-000	SHOWER DRAIN, BRASS BODY/CHROME COVER	40
B	27254-002-000	SHOWER SOAP TRAY WITH STAINLESS STEEL WALL HOUSING	108
C	27254-102-000	SHOWER SOAP TRAY WITH POWDER COATED WHITE WALL HOUSING	108
D	27254-009-020	REPLACEMENT CLEAR SOAP TRAY	400

AROMATHERAPY

LOW PROFILE AROMA THERAPY INJECTOR

PRODUCT FEATURES

- Low Profile Installation
- Bead or Strip Dispenser Compatible
- 1" Slip × 1" Slip



SCENTED BEAD BASKETS

PRODUCT FEATURES

- Compatible with all CMP Aroma Therapy Injectors
- Nine Scent Options, or Empty Basket Available



ORDERING GUIDE

REF	CMP P/N	DESCRIPTION	BOX QTY
AROMA THERAPY			
A	24040-100-000	LOW PROFILE STRIP DISPENSER ASSEMBLY	120
B	24040-000-000	LOW PROFILE BEAD DISPENSER ASSEMBLY	120
—	24040-000-030	LOW PROFILE CAP ONLY	500
—	24040-000-100	LOW PROFILE BEAD BODY ASSEMBLY (BODY, NUT, GASKET, WALL FITTING)	100
—	24040-100-100	LOW PROFILE STRIP BODY ASSEMBLY (BODY, NUT, GASKET, WALL FITTING)	100
C	23040-110-000	AROMA THERAPY INJECTOR BASKET WITH BEADS, ORANGE	10
C	23040-120-000	AROMA THERAPY INJECTOR BASKET WITH BEADS, VANILLA	10
C	23040-140-000	AROMA THERAPY INJECTOR BASKET WITH BEADS, EUCALYPTUS	10
C	23040-400-000	AROMA THERAPY INJECTOR BASKET WITH BEADS, ROSE	10
C	23040-600-000	AROMA THERAPY INJECTOR BASKET WITH BEADS, CITRUS	10
C	23040-700-000	AROMA THERAPY INJECTOR BASKET WITH BEADS, COOL MINT	10
C	23040-900-000	AROMA THERAPY INJECTOR BASKET WITH BEADS, MELON	10
C	23040-130-000	AROMA THERAPY INJECTOR BASKET WITH BEADS, WILD BERRY	10
C	23040-800-000	AROMA THERAPY INJECTOR BASKET WITH BEADS, LAVENDER	10
C	23040-000-020	AROMA THERAPY INJECTOR BASKET (NO BEADS)	10

CHROMATHERAPY

Light fittings for LEDs spots and light fixtures available in modern and traditional styles. For a complete LED light, see the Nexxus LED Light on page 50.

SÖL BATH LIGHT

PRODUCT FEATURES

- 304 Stainless Steel Trim
- Flush Installation
- Complements other SÖL Products



SÖL
BATH COLLECTION

See the complete
SÖL series on page 70

3" BATH LIGHT



2-1/2" Hole Size
Rear Access



LIGHT ACCESSORIES

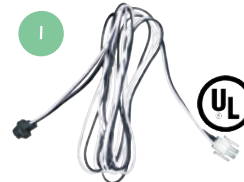
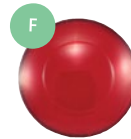
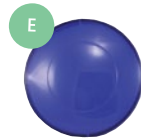

ORDERING GUIDE

REF	CMP P/N	DESCRIPTION	BOX QTY
CHROMATHERAPY			
A	25234-000-000	SÖL FLUSH LED LIGHT CLEAR LENS	100
A	25234-002-005	SÖL FLUSH LED LIGHT CHROME RING	100
A	25234-000-003	SÖL FLUSH LED LIGHT WASHER	100
A	25234-000-002	SÖL FLUSH LED LIGHT NUT	100
D	25241-000-000	3" LIGHT KIT (LENS, NUT, GASKET, REFLECTOR HOUSING)	100
—	25241-000-100	LENS, GASKET, & NUT FOR 3" LIGHT	100
—	25241-000-050	3" REFLECTOR HOUSING ONLY	100
E,F	25241-000-160	3" RED & BLUE LENS COVER KIT	100
H	25239-000-000	LIGHT BULB, GE 912	10
I	25241-000-300	BATH LIGHT WIRE HARNESS WITH AMP CONNECTOR	100
—	26400-000-000	LED LAMP WITH WHITE TRIM RING FOR NEXXUS CONTROLS (SEE PG 50)	—
—	26400-002-000	LED LAMP WITH CHROME TRIM RING FOR NEXXUS CONTROLS (SEE PG 50)	—
—	25241-000-200	BATH LIGHT WIRE HARNESS "PIGTAIL" ONLY	600
—	25241-000-500	MOLEX CONNECTOR	200
—	25242-000-000	5" LIGHT KIT (LENS, NUT, GASKET, REFLECTOR HOUSING)	50
—	25242-002-000	5" LIGHT KIT, STAINLESS STEEL (LENS, NUT, GASKET, REFLECTOR HOUSING)	50
—	25242-000-061	5" RED & BLUE LENS COVER KIT	250/25
—	25242-006-101	5" RED LIGHT LENS COVER	50
—	25242-007-101	5" BLUE LIGHT LENS COVER	50
—	25242-009-101	5" GREEN LIGHT LENS COVER	50

ADA GRAB BARS & SHOWER SEATS

SHOWER SEATS

PRODUCT FEATURES

- White Cushion Seat
- "L" Seat or Bench Style
- Right or Left Configuration Available
- White or Wood Grain Phenolic*

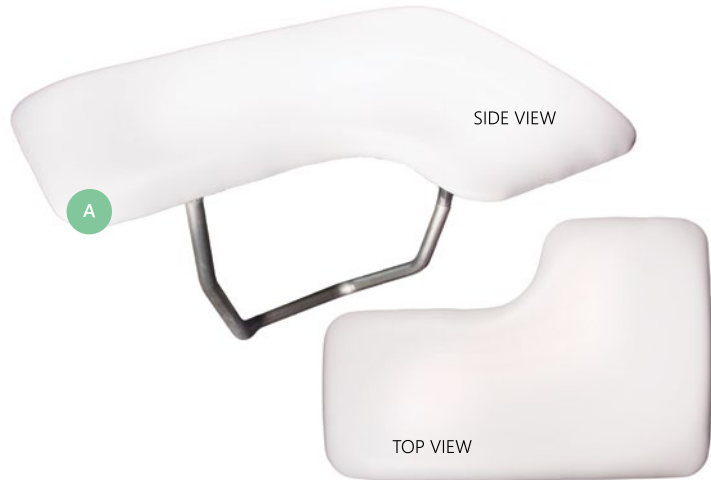

ADA GRAB BARS

PRODUCT FEATURES

- 304 Stainless Steel Grab Bars
- Satin Stainless or White Powder Coated
- 1-1/2" Diameter Concealed Screws
- Bulk Packaging 2,4, or 5 each Depending on Size/Shape
- Straight, "L" Shape, or "U" Shape Available

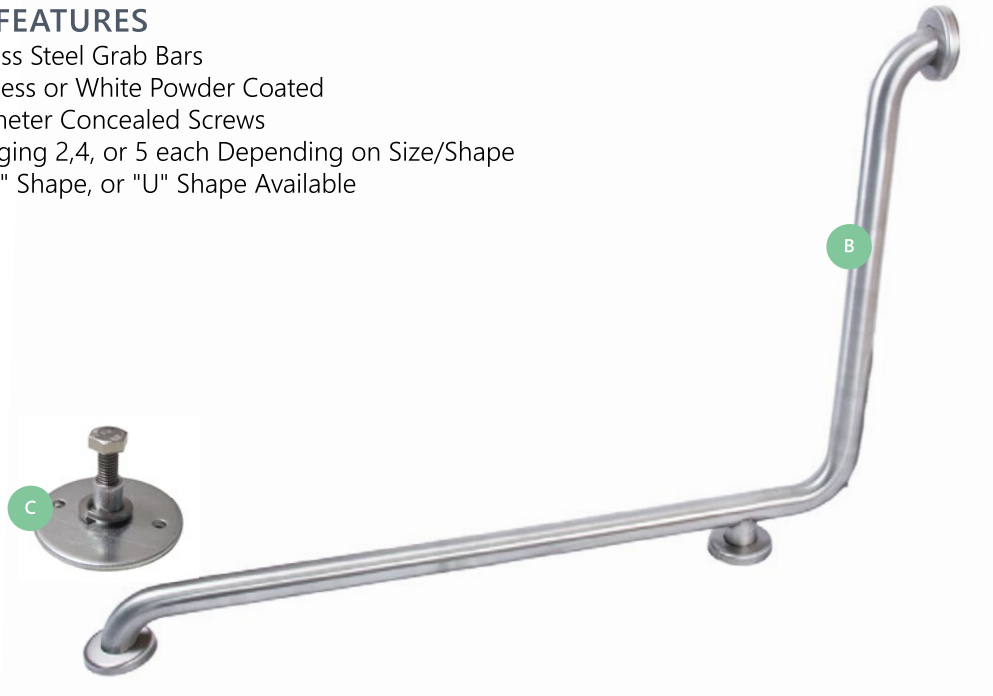

ORDERING GUIDE

REF	CMP P/N	DESCRIPTION	BOX QTY
ADA GRAB BARS & SHOWER SEATS			
A	27250-210-000	RIGHT HAND "L" SEAT, 27" × 22-1/2"	1
A	27250-110-000	LEFT HAND "L" SEAT, 27" × 22-1/2"	1
A	27250-200-000	RIGHT HAND "L" SEAT, 32" × 22-1/2"	1
A	27250-100-000	LEFT HAND "L" SEAT, 32" × 22-1/2"	1
—	27250-000-000	BENCH SEAT, 18" × 15"	1
B	27251-XXX-XXX	GRAB BARS - CONTACT CMP FOR COMPLETE LIST OF SIZES AND SHAPES	—
C	27251-100-000	OPTIONAL THREADED FLANGE FOR GRAB BARS	400

*NON-STOCK SPECIAL ORDER ONLY ITEM

SHOWER RODS & CURTAINS

PRODUCT FEATURES

- Heavy Duty PVC Material Curtains
- Anti-Bacterial Additive in each Curtain
- Standard or Weighted* Available
- 1" OD Shower Rods with Two Flanges & Four Screws
- **Shower Hooks & Rods are Sold Separately**



ORDERING GUIDE

REF	CMP P/N	DESCRIPTION	HOOKS REQUIRED	BOX QTY
SHOWER RODS & CURTAINS				
A	27252-360-000	36" x 72" SHOWER CURTAIN	6	24
A	27252-480-000	48" x 72" SHOWER CURTAIN	8	24
A	27252-540-000	54" x 72" SHOWER CURTAIN	10	20
A	27252-720-000	72" x 72" SHOWER CURTAIN	12	12
A	27252-720-200	72" x 72" WEIGHTED SHOWER CURTAIN*	12	12
A	27252-480-200	48" x 72" WEIGHTED SHOWER CURTAIN*	8	24
B	27252-000-000	SHOWER CURTAIN HOOK	—	100
C	27252-360-100	36" SHOWER ROD, 1" O.D..	—	20
C	27252-480-100	48" SHOWER ROD, 1" O.D.	—	20
C	27252-600-100	60" SHOWER ROD, 1" O.D.	—	20

*NON-STOCK SPECIAL ORDER ONLY ITEM



INFORMATION & REFERENCE

PART NUMBER INDEX 88

TERMS & CONDITIONS 91

LIMITED WARRANTY 92

ISO CERTIFICATION 94

PART#	PG	PART#	PG	PART#	PG	PART#	PG
21005-000-000	74	21081-900-000	76	23061-002-000	19	23422-500-000	30
21008-000-000	74	21086-000-000	76	23061-010-000	19	23422-500-100	30
21009-000-000	74	21105-000-000	74	23061-132-002	19	23422-500-500	30
21010-000-000	74	21131-100-010	76	23061-132-003	19	23422-999-999	30
21010-200-000	74	21155-060-000	76	23061-999-999	19	23432-000-010	28, 29
21011-000-000	74	21156-020-000	76	23062-000-100	26	23432-000-040	28, 29
21012-000-000	74	21157-020-000	76	23062-000-200	26	23432-000-050	28, 29
21013-000-000	74	21157-040-000	76	23062-020-000	26	23432-500-000	28
21013-200-000	74	21157-520-000	76	23062-050-000	26	23432-500-100	28
21014-000-000	54, 56	21159-040-000	76	23062-999-999	26	23432-500-500	28
21014-100-000	75	21159-050-000	76	23070-000-000	25	23432-700-000	29
21015-000-000	74	21162-080-000	76	23070-000-100	25	23432-700-100	29
21016-000-000	74	21162-120-000	76	23070-000-200	25	23432-700-500	29
21017-000-000	74	22005-100-000	77	23070-030-000	25	23432-999-999	28, 29
21018-000-000	74	22010-050-000	77	23070-130-000	25	23500-300-000	32
21018-100-000	74	22015-050-000	77	23070-200-000	25	24000-000-200	13, 14
21019-000-000	74	22020-050-000	77	23070-200-200	25	24000-000-205	22
21020-000-000	74	22143-500-000	77	23071-000-000	24	24000-000-220	13, 14
21021-000-000	54, 56	22143-500-010	77	23071-000-100	24	24000-000-225	22
21021-008-000	75	22145-400-100	77	23071-000-200	24	24000-000-300	14
21021-030-000	75	22180-100-000	77	23071-030-000	24	24000-000-305	14
21021-800-000	75	23035-000-000	60	23072-000-000	24, 25	24000-000-320	14
21021-900-000	75	23036-000-000	60	23400-400-030	33	24000-000-325	14
21022-000-000	19, 76	23037-000-000	60	23400-400-060	33	24001-000-200	15, 22
21023-000-000	75	23037-010-000	60	23400-500-000	33	24001-000-201	38
21028-000-000	76	23037-030-000	60	23400-600-000	33	24001-000-221	38
21031-030-000	76	23038-000-000	60	23400-800-010	16	24031-000-100	66
21033-000-000	76	23038-010-000	60	23400-800-030	16	24031-100-000	66
21034-600-000	33	23039-000-010	60	23400-800-100	16	24031-800-100	66
21039-000-900	57	23039-002-000	60	23400-840-040	16	24032-000-020	67
21042-600-000	33	23039-010-000	60	23400-900-000	31	24032-000-100	67
21042-900-000	33	23039-020-000	60	23400-900-030	31	24032-100-000	67
21043-000-000	76	23039-025-000	60	23400-900-050	31	24032-900-000	67
21045-004-000	75	23040-000-020	82	23400-900-060	31	24038-000-100	67
21046-000-000	75	23040-100-000	82	23400-900-080	16	24038-100-000	67
21047-000-000	75	23040-110-000	82	23400-900-100	31	24039-000-030	66
21052-100-000	76	23040-140-000	82	23400-940-040	31	24039-000-060	66, 67
21064-000-000	75	23040-400-000	82	23400-950-060	31	24039-000-100	66
21064-000-010	75	23040-600-000	82	23400-950-080	16	24039-100-000	66
21064-500-000	75	23040-700-000	82	23400-999-999	31	24039-100-010	66, 67
21065-000-000	76	23040-900-000	82	23401-900-000	31	24039-200-020	66, 67
21080-000-000	76	23061-000-000	19, 26	23401-900-100	31	24040-000-000	82
21081-000-000	76	23061-000-100	19	23422-000-010	30	24040-000-030	82
21081-060-000	76	23061-000-133	19	23422-000-040	30	24040-000-100	82
21081-060-020	76	23061-000-200	19	23422-000-050	30	24040-100-000	82

PART#	PG	PART#	PG	PART#	PG	PART#	PG
24040-100-100	82	24300-100-300	23	25014-002-000	65	25202-000-200	71
24100-000-010	15	24300-200-000	23	25014-050-000	63, 64	25202-900-000	70, 72
24100-000-040	22	24300-299-999	23	25014-800-000	62	25202-999-999	71
24100-000-052	22	24300-300-000	23	25015-000-000	64	25204-001-000*	73
24100-000-070	22	24300-799-999	23	25015-000-100	65	25205-000-000	73
24100-000-080	38	24375-000-000	77	25015-000-200	64	25205-070-000	73
24100-000-090	13, 38	24400-000-000	21	25015-002-000	64	25206-000-000	73
24100-000-094	15	24400-000-004	21	25015-100-000	64	25206-000-032	73
24100-000-100	22	24400-000-005	21	25024-000-000	64	25206-000-033	73
24100-000-200	13, 14	24400-000-006	21	25024-000-100	64	25206-000-200	73
24100-000-211	38	24400-000-007	21	25024-000-132	64	25206-100-000	73
24100-000-220	13, 14	24400-000-008	21	25024-000-133	64	25206-100-150	73
24100-000-300	22	24400-000-011	21	25024-000-200	64	25206-100-200	73
24100-000-400	22	24400-100-000	21	25024-002-000	64	25206-500-000	73
24100-000-500	22	24400-999-999	21	25024-003-000	64	25216-000-000	72
24100-000-600	12	24401-100-000	21	25025-000-000	63	25216-000-030	70, 72
24100-000-603	12	24500-900-000	32	25025-000-110	63	25216-000-100	70, 72
24100-000-700	12	24500-999-999	32	25025-002-000	63	25216-000-200	72
24100-000-800	22	24510-900-000	32	25025-003-000	63	25216-100-100	70, 72
24100-000-900	13	24522-000-000	32	25026-000-030	73	25216-100-302	70
24100-000-910	13	24530-000-000	32	25040-019-050	63	25216-100-400	70
24100-000-999	38	24600-000-000	17	25060-000-000	75	25216-102-302	70
24100-002-603	12	24600-000-010	11, 17	25062-000-000	75	25216-200-030	70, 72
24100-002-700	12	24600-000-020	11, 17	25066-275-000	75	25216-200-200	72
24100-012-600	12	24600-000-030	17	25066-375-000	75	25216-250-200	70
24100-100-100	22	24600-000-040	17	25067-000-000	75	25216-300-000	70
24100-500-000	14	24600-000-100	17	25069-000-000	75	25216-500-000	70
24100-500-030	14	24600-000-200	11	25069-100-000	75	25216-500-200	72
24100-500-040	14	24600-399-999	17	25070-000-100	75	25216-550-200	70
24100-500-070	14	24600-999-999	17	25083-000-000	63	25216-999-999	72
24100-500-100	14	24601-000-001	11	25083-000-040	63	25234-000-000	83
24100-900-000	22, 25	24601-002-000	11	25083-000-041	63	25234-000-002	83
24100-999-999	14, 22	24601-002-030	11	25083-000-110	63	25234-000-003	83
24101-000-200	15, 22	24601-002-040	11	25083-002-000	63	25234-002-005	83
24101-000-220	12, 15	25013-000-000	65	25083-003-000	63	25239-000-000	83
24101-000-221	38	25013-000-030	65	25083-100-000	63	25241-000-000	83
24101-000-600	12	25013-000-100	65	25083-200-000	63	25241-000-050	83
24200-100-000	76	25013-000-110	65	25083-200-040	63	25241-000-100	83
24200-200-000	74	25013-000-200	65	25083-300-100	63	25241-000-160	83
24200-300-000	76	25013-000-300	64	25083-800-000	62	25241-000-200	83
24200-400-000	77	25013-634-500	65	25083-802-000	62	25241-000-300	83
24300-000-070	23	25013-652-800	65	25202-000-000	71	25241-000-500	83
24300-100-000	23	25014-000-000	65	25202-000-030	71	25242-000-000	83
24300-100-100	23	25014-000-100	64	25202-000-040	71	25242-000-061	83
24300-100-200	23	25014-000-200	65	25202-000-100	71	25242-002-000	83

PART#	PG	PART#	PG	PART#	PG	PART#	PG
25242-006-101	83	26400-900-909	52	27250-210-000	84	27270-999-999	18
25242-007-101	83	26400-901-202	51	27251-100-000	84	27272-300-100	20
25242-009-101	83	26404-100-110	48	27252-000-000	85	27272-300-120	20
25300-000-070	75	26404-102-100	48	27252-360-000	85	27272-300-200	20
25522-256-266	60	26406-000-103	49	27252-360-100	85	27320-400-000	59
25523-500-010	73	26406-002-101	49	27252-480-000	85	27320-400-100	59
25577-950-020	76	26406-002-103	49	27252-480-100	85	27320-700-000	59
26200-230-601	19	26410-002-100	47	27252-480-200	85	27320-700-100	59
26203-202-215	33	26410-002-110	47	27252-540-000	85	27320-900-000	59
26204-102-820	65	26413-100-110	46	27252-600-100	85	42009-200-000	56
26204-653-820	63	26413-102-100	46	27252-720-000	85	42009-200-100	55, 57
26205-554-230	26, 64	27112-000-000	19	27252-720-200	85	61000-050-012	71, 73
26205-804-330	24, 25	27210-000-100	55, 56	27253-002-000	81	61000-506-005	70
26207-705-930	73	27210-060-000	55	27254-002-000	81	61000-506-025	72
26400-000-000	50, 83	27210-080-000	55	27254-009-020	81		
26400-000-901	45	27210-090-000	55	27254-102-000	81		
26400-000-902	45	27210-110-000	55	27264-202-000	80		
26400-000-904	45	27210-130-000	55	27264-203-000	80		
26400-000-905	53	27213-050-000	54	27264-208-000	80		
26400-000-906	45	27213-070-000	54	27264-213-000	80		
26400-002-000	50, 83	27213-090-000	54	27265-204-000	54, 56		
26400-100-110	48	27213-130-000	54	27266-000-000	75		
26400-100-111	48	27216-050-000	54	27267-001-000	75		
26400-100-112	48	27216-070-000	54	27268-150-000	58		
26400-100-113	48	27217-090-000	54	27268-320-000	58		
26400-100-114	48	27217-130-000	54	27269-009-000	58		
26400-102-100	48	27239-000-900	55, 75	27269-009-030	58		
26400-102-101	48	27239-020-000	56	27269-009-100	58		
26400-102-102	48	27239-032-000	56	27269-150-000	58		
26400-102-103	48	27239-038-000	56	27269-650-000	58		
26400-102-104	48	27239-046-000	56	27270-000-000	27		
26400-180-110	51	27239-058-000	56	27270-000-070	18		
26400-180-210	51	27239-070-000	56	27270-100-050	27		
26400-180-310	51	27239-075-000	57	27270-100-200	27		
26400-900-000	51	27239-075-100	57	27270-200-000	27		
26400-900-001	52	27239-100-000	57	27270-300-040	20		
26400-900-002	51	27239-100-100	57	27270-399-999	20		
26400-900-003	51	27239-120-000	57	27270-400-000	20		
26400-900-006	51	27239-120-100	57	27270-400-100	20		
26400-900-007	52	27240-148-000	38	27270-400-500	20		
26400-900-010	52	27240-248-000	38	27270-900-000	18		
26400-900-301	50, 51	27250-000-000	84	27270-900-050	18		
26400-900-304	50	27250-100-000	84	27270-900-060	18		
26400-900-310	50	27250-110-000	84	27270-900-100	18		
26400-900-900	52	27250-200-000	84	27270-900-999	18		

TERMS & CONDITIONS

CONTACT For written communication, including payment of invoices, please send to:
Custom Molded Products, LLC
36 Herring Road
Newnan, GA 30265
Phone: 770-632-7112 Fax: 770-632-7115

ORDERING Customers should place orders directly with Custom Molded Products at the phone or fax numbers presented above. To ensure prompt and proper shipment, please order by using complete part numbers and descriptions. All telephone orders must be followed up with a written confirmation purchase order.
Our catalog and price list contain box/bag quantities for most parts. Currently CMP does not apply a surcharge for broken carton orders. Please help us maintain this policy by ordering in full carton quantities.
Thank you for your cooperation!

TERMS Payment for products is C.O.D. Net terms may be established upon completion of a satisfactory credit check. Past due accounts will be C.O.D. Customers with unpaid balances will be considered delinquent and will be subject to a service charge of 1-1/2% per month on the past due amount.

FREIGHT Pricing and terms are FOB–Newnan, Georgia unless otherwise specified. Freight charges are Pre-Pay and Add unless otherwise specified. All claims for lost or damaged freight must be made by the purchaser and directly to the freight carrier within the carrier’s established time limit.

INVOICES Please pay by invoice per the terms on the sales invoice. There will be a \$20.00 minimum service charge on all NSF or returned checks.

BILLING ERRORS Appropriate debits or credits will be applied to accounts or invoices that are in error. Please contact Custom Molded Products if you have questions regarding your invoice or if you think your account is in error.

RETURNED GOODS Merchandise will not be accepted for return without a Returned Materials Authorization (RMA) number issued by Custom Molded Products, which should be marked on all returned cartons. Returned shipments not having prior authorization will be refused. All returned merchandise must be new and unused with the exception of defective goods. A 25% restocking charge will be applied against any credit issued for salable merchandise. All goods must be returned freight pre-paid within 30 days after receipt of shipment.

NOTICE Custom Molded Products reserves the right to change at any time and without notice colors, materials, specifications, part numbers and prices to any products appearing in this publication.

CMP LIMITED WARRANTY

Custom Molded Products, LLC takes great pride in the quality products that it manufactures. The company maintains high standards for the materials and workmanship that it invests in its products. Accordingly, Custom Molded Products makes this express Limited Warranty with respect to products manufactured solely by Custom Molded Products, LLC, as follows:

Custom Molded Products warrants its products to be free of defects in material and workmanship for a period of one (1) year from the date of original purchase of the Custom Molded Products product. This Limited Warranty will be applicable only if the product manufactured by Custom Molded Products is the sole and exclusive cause of a defect which is covered by this Limited Warranty. Your sole and exclusive remedy against Custom Molded Products, LLC, arising from the purchase or use of a product manufactured by Custom Molded Products, LLC is limited to the repair or supply of a replacement product in substitution of the product which is determined to be defective (after examination, verification and approval by Custom Molded Products, LLC) with a product of equivalent quality. All other compensation of whatever nature is hereby expressly excluded. This Limited Warranty begins on the date of first purchase of a product from Custom Molded Products, LLC

The Limited Warranty is extended to the party making the original purchase of products from Custom Molded Products, LLC and no warranty is made nor authorized to be made assignable on resale by the original purchaser of products from Custom Molded Products, LLC The repair or replacement product issued by Custom Molded Products, LLC pursuant to this Limited Warranty shall be warranted for only the unexpired portion of the original Limited Warranty.

This Limited Warranty does not apply to component parts manufactured by others or for damage to products manufactured by Custom Molded Products, LLC if such damage is caused by component parts manufactured by others. For component products manufactured by others the warranty established by that respective manufacturer, if any, will be applicable.

THIS LIMITED WARRANTY DOES NOT COVER:

- Costs incurred in the shipment or cartage, removal and/or re-installation (including but not limited to labor costs) with respect to the replacement product made available by Custom Molded Products, LLC pursuant to this Limited Warranty.
- Damage or improper operation of a product governed by this Limited Warranty to the extent same is caused by customer abuse, misuse, negligence, or failure to follow installation or operation instructions.
- Use for which the product is not designed.
- Fire, explosion, weather conditions or natural disasters.
- Faulty or improper installation.
- Ordinary wear and tear.
- Damage caused by negligent or improper maintenance procedures and other causes not specified, by beyond the control of Custom Molded Products, LLC
- Improper packaging, repackaging or damage incurred in shipping.

In order for this Limited Warranty to be effective you must:

- Be the original purchaser of the product from Custom Molded Products, LLC
- Have not structurally modified, misused or misapplied the product manufactured by Custom Molded Products
- Have maintained the Custom Molded Products product in accordance with the instructions from Custom Molded Products, LLC or as described in maintenance materials provided by Custom Molded Products, LLC to you
- Have complied with all terms for the payment of the Custom Molded Products product
- Made your claim in writing to Custom Molded Products within the time provided and in accordance with the terms of this Limited Warranty.

CMP LIMITED WARRANTY

THERE ARE NO WARRANTIES APPLICABLE TO PRODUCTS MANUFACTURED BY CUSTOM MOLDED PRODUCTS EXCEPT AS EXPRESSLY STATED HEREIN AND THIS WARRANTY IS IN SUBSTITUTION FOR AND IN LIEU OF ALL OTHER WARRANTIES, WHETHER EXPRESSED OR IMPLIED, INCLUDING WITHOUT LIMITATION, ANY WARRANTIES OF MERCHANTABILITY OR FITNESS FOR A PARTICULAR PURPOSE.

UNDER NO CIRCUMSTANCES SHALL CUSTOM MOLDED PRODUCTS BE LIABLE FOR ANY LOSS OR ANY DIRECT, INDIRECT, INCIDENTAL, SPECIAL OR CONSEQUENTIAL DAMAGE OR COSTS. CUSTOM MOLDED PRODUCTS SHALL NOT BE LIABLE FOR ANY LOSS OF USE, INCOME OR PROFIT, DAMAGE TO OTHER PROPERTY, ATTORNEY'S FEES OR THIRD PERSON CLAIMS NOT WITHSTANDING A PRIOR NOTICE TO THAT EFFECT FROM THE BUYER OR UNDER ANY OTHER CIRCUMSTANCES.

CUSTOM MOLDED PRODUCTS SHALL HAVE NO LIABILITY TO THE BUYER AND SHALL HAVE NO RESPONSIBILITY FOR THE COSTS OF LABOR, TRANSPORTATION OR OTHER COST INCURRED IN THE REMOVAL AND/OR INSTALLATION OF PRODUCTS MANUFACTURED BY CUSTOM MOLDED PRODUCTS COVERED BY THIS WARRANTY.

THE SOLE AND EXCLUSIVE REMEDY FOR CUSTOM MOLDED PRODUCTS' LIABILITY OF ANY KIND AND THE SOLE AND EXCLUSIVE REMEDY OF THE BUYER, WHETHER IN LAW OR IN EQUITY FOR A BREACH BY CUSTOM MOLDED PRODUCTS OF ANY AND ALL WARRANTIES SHALL BE LIMITED TO THE REPAIR OF, OR AT CUSTOM MOLDED PRODUCTS' OPTION, THE REPLACEMENT OF PRODUCTS MANUFACTURED BY CUSTOM MOLDED PRODUCTS WHICH ARE COVERED BY THIS WARRANTY.

This warranty is valid only in the United States of America.

TIME LIMIT ON COMMENCING LEGAL ACTION

It is agreed that you have 30 days from the accrual of a claim to inform CUSTOM MOLDED PRODUCTS, LLC by registered mail with acknowledgment of receipt. It is agreed that you have one year from the accrual of a claim to commence any legal action arising from the purchase of a product manufactured by CUSTOM MOLDED PRODUCTS, LLC

This Limited Warranty shall be governed by and construed in accordance with laws of the State of Georgia, except as to its principles of conflicts of laws, and CUSTOM MOLDED PRODUCTS, LLC and you irrevocably submit to the jurisdiction of the State of Georgia and the venue of Coweta County in any action brought by the parties hereto concerning this Limited Warranty or the performance by CUSTOM MOLDED PRODUCTS, LLC thereunder.

For communication related to replacement products or other issues respecting this Limited Warranty, please contact:

Custom Molded Products, LLC
36 Herring Road, Newnan, Georgia 30265
Phone: 770.632.7112 FAX: 770.632.7115

ISO CERTIFICATION



Custom Molded Products, LLC

announces that the quality management system of Custom Molded Products, Inc, a wholly-owned subsidiary of CMP, has been assessed and registered by Intertek as conforming to the requirements of:

ISO 9001:2008

The facility is thereby an ISO certified and Intertek registered company. This registration is subject to the company maintaining a Quality Management System to the above standard, which will be monitored by Intertek.

Please consult the website <http://www.cnca.gov.cn> for further information.



Certificate Number: 111511012

Date: 08 January 2016

Valid Until: 14 September 2018

EAC Code: 14

Have you been to c-m-p.com?



THE PREMIER WEBSITE FOR BATH PROFESSIONALS

MOBILE DEVICE COMPATIBLE

WORLDWIDE REP LOCATOR

SPANISH TRANSLATION

**DIGITAL CMP CATALOGS,
GUIDES & MANUALS**

**NEW PRODUCT INFO,
GUIDES & UPDATES**



STAY UP TO DATE WITH CMP

Quarterly CMP Newsletter Updates

Exclusive Special Offers & Promotions

Updates, product info & professional resources
at C-M-P.COM/NEWS

THE PREMIER SUPPLIER OF POOL, SPA & BATH COMPONENTS

Pool, Spa, and Bath industry professionals around the world all depend on CMP. If you are a spa designer, pool builder, bath manufacturer or retail store owner, you can depend on CMP products, service and support. Because when the difference is in the details, everything matters®.

CMP® everything matters.

www.c-m-p.com

1-800-733-9060

ORDERS: CS@c-m-p.com

PRODUCT INFO: SpaSales@c-m-p.com

36 HERRING ROAD, NEWNAN, GA 30265